

OPERATING INSTRUCTION

ESC300

Electronic Control Comfort



Read this operating instruction with care before
commissioning!



INFORMATION

The figure- and graphic expositions in this operating instruction might deviate partially a little from your control, by virtue of technical modification!

*All features, components or parts marked with a * are options or accessories and because of that not available on each control! Instructions and descriptions for extensions, additional equipment and -functions you can find enclosed to this operating instruction.*

Please read this operating instruction with care before commissioning.

Keep this instruction with care for further assignment!

Service-Address



Before contacting our service note down the following...

- *the specific name and model of the machine (name plate)*
- *the serial number of the machine (name plate)*
- *the displayed error message*

In case of malfunctions and technical problems:

Phone: +49 (0) 7336 - 961018 or **E-mail:** service-et@prinzing.eu

For spare parts orders:

Phone: +49 (0) 7336 - 9610-0 • **Fax:** +49 (0) 7336 - 961050 • **E-mail:** entmistung@prinzing.eu

Postal address: Peter Prinzing GmbH - Siechenlach 2 - 89173 Lonsee-Urspring, Deutschland

Or contact your local dealer.

Your customer number
(see invoice/delivery note)

Serial number
(see name plate on the control)

Date:	20-11-2014	Data name:	esc300-2-v12a_EN	ESC300 (swv-1.06)
Author:	Heiko Lange	Pages:	72	© P. Prinzing GmbH - 89173 Lonsee-Urspring (Germany)

1.	Before using	6
1.1.	Copyright	6
1.2.	Intended using	6
1.3.	Used characters and symbols	7
1.4.	Definition:	7
1.5.	Overview components of the electronic control Comfort ESC300	8
1.6.	Functions of the electronic control Comfort	9
2.	Assembling and connection	10
2.1.	Assembling the control ESC300	10
2.2.	Assembling the charge ESC300	11
2.3.	Assembling the radio module	11
2.4.	Assemble the control Expansion for alley 4 - 6	11
2.5.	Assemble the temperature sensor	11
2.5.1	Assembling example for the control and its components	12
2.6.	Electrical connection	13
2.6.1	Cable types, line length and cable cross section	14
2.6.2	Connection of the electronic control - ESC300	15
2.6.3	Connection expansion module - EXP300	15
2.6.4	Connection of the charging station ESC300 Charge	16
2.6.5	Connection optional equipment (end switch, push button, signal transmitter)	16
3.	Safety	17
3.1.	General safety advices	17
3.2.	Behaviour in danger situations	17
3.3.	Danger areas of the dung removal system	18
3.4.	Danger by electric energy	18
3.5.	Unattended operation (automatic) of the dung removal system	19
3.6.	Danger of self-depended starting scraper	19
3.7.	Attach warning- and information signs	19
4.	The radio controlled remote ESC300	20
4.1.	How to use the remote ESC300	21
4.2.	Display messages during the „operation mode“	22
4.3.	Display messages during the „setting mode“	23
5.	Commissioning	24
5.1.	Switch on the control	24
5.2.	Set language - date - time	24
5.3.	Switch off or on again the alleys	25
5.4.	Commissioning of one alley	25
5.4.1	Chose motor type (nominal capacity)	26
5.4.2	Do the motor test (rotating direction)	27
5.5.	Do the program „learning“	27
5.6.	Programs on the control	29
5.6.2	Program 1 (P1) - description	30
5.6.1	Program 2 (P2) - description	30
5.6.3	Program 3+4 (teaching) - description	31
5.6.4	Set starting times in the schedule (Timer)	33
6.	Extended functions	34
6.1.	Function drive	34
6.1.1	Connect signal device for „drive“	35
6.2.	Function slatted floor	36
6.3.	Function frost mode	37
6.3.1	Set the parameters for the frost mode	38
6.3.2	Set the frost mode for an alley	39
6.4.	Set the obstacle detection	40
6.5.	Parking position	41
6.6.	Start the cross transport automatically	42

Date:	20-11-2014	Data name:	esc300-2-v12a_EN	ESC300 (swv-1.06)
Author:	Heiko Lange	Pages:	72	© P. Prinzing GmbH - 89173 Lonsee-Urspring (Germany)

* Option / depends on design

Service: +49 (0) 7336 - 961018

7.	Operation with the ESC300	43
7.1.	Manual operation with the electronic control ESC300	43
7.2.	Automatic operation with the electronic control ESC300	44
7.2.1	Automatic operation by schedule (Timer).....	44
7.2.2	Automatic operation by frost mode	45
7.3.	Operation of the control by external push button*	45
7.4.	Switch over and off the scraper move by the end switch*	45
8.	Service	46
8.1.	Change parameters and program settings	46
8.1.1	Change the learned breaking current.....	47
8.1.2	Change parameter program 2 (P2).....	48
8.2.	Display system information	50
8.3.	Do a system diagnosis	50
8.4.	The signal output „cross transport“ and „error“	51
8.5.	The tension control.....	52
8.6.	Die SD-card (data saver)	52
8.6.1	Insert/extract the SD-card	53
8.6.2	Save parameters (export)	53
8.6.3	Load parameters (import).....	54
8.6.4	Logging on the SD-card	55
8.6.5	Software-Update with a SD-card.....	55
8.7.	Failure and error deletion	56
8.7.1	Error messages on the display - cause and deletion	56
8.7.2	Error codes.....	57
8.7.3	Info messages (display glows yellow)	58
8.7.4	Errors during the operation (display glows red) - cause and deletion	58
8.7.5	Further errors	59
8.8.	Batteries on the remote - care and replacement.....	60
8.9.	Factory provided (Reset).....	61
9.	Factory provided parameters	62
10.	Disassembly and Disposal	63
11.	Technical data	64
12.	Explorer menu ESC300	65
	Electrical installation plan	
	Electrical connection plan	

Original operating instruction

The German layout of this document is the original operating instruction.

Translation of the original operating instruction

All non german layouts of this document are translations of the original operating instruction.

Operating instruction ESC300

Version: 12b

Valid from software version *control 1.12*

© 2014

Date:	20-11-2014	Data name:	esc300-2-v12a_EN	ESC300 (swv-1.06)
Author:	Heiko Lange	Pages:	72	© P. Prinzing GmbH - 89173 Lonsee-Urspring (Germany)

Declaration of Incorporation

Corresponding the EC-directive machines 2006/42/EC, annex II, no. 1 B

Herby we declare, that the undermentioned Dung Removal System including the parts belonging to and mounted parts are corresponding to the primary safety and healthy requirements of the EC-Directive 2006/42/EC in their conception and construction in the version market by us. Is only allowed to commission the Dung Removal System, when it is sure, that the Dung Removal System corresponds to the regulations of the EC-directive machines 2006/42/EC.

Manufacturer:

Peter Prinzing GmbH
Siechenlach 2
89173 Lonsee-Urspring (Germany)

Phone +49 (0) 7336 / 9610-0
Internet: www.prinzing.eu
e-Mail: info@prinzing.eu

Description:

Type/Model: Electronic Control Comfort - ESC-300
Consisting of: Box incl. 1x Control and up to 2x Relay, 1x Remote, 1x Charge, 1x Radio Module
Expandable with: EXP-300 with up to 3x Relay, additional radio module
Function: Control of up to 12 drive winches for a Wire Rope Dung Removal System
Serial-Number: See name plate

It explains the compliance with further following for the product applicable policies, regulations and standards:

- EMV-directive: (2004/108/EC) dated 15. December 2004
- Transient emissions: EN 55011:2009 + A1:2010 class B
EN 61000-6-3:2007 + A1:2011
EN 61000-6-4:2007 + A1:2011
- Interference resistance: EN 61000-6-2:2005

The special technical documents corresponding annex VII B were created. They will be forwarded to the competent national authority to a reasoned request in electronic form or by post.

Authorised person for the technical documentation:

Heiko Lange
Siechenlach 2
89173 Lonsee-Urspring (Germany)
Phone.: +49 (0) 7336 / 961018

Place/Date:

Lonsee-Urspring, 16.02.2012

Information to the authorized person for issuing this declaration:

Peter Prinzing, Manager

Signature:



Date:	20-11-2014	Data name:	esc300-2-v12a_EN	ESC300 (swv-1.06)
Author:	Heiko Lange	Pages:	72	© P. Prinzing GmbH - 89173 Lonsee-Urspring (Germany)

* Option / depends on design

Service: +49 (0) 7336 - 961018

1. Before using



INFO

Please read this operating instruction with care before mounting and assembling the control ESC300. Thereby you are able to avoid errors during the assembling/operation and you can learn to use the characteristics and the functions of the ESC300 control in an optimal way. If you have questions concerning the function or how to operate with the control, please contact our service or your local dealer.

1.1. Copyright

The copyright for this installation and operating instruction belongs to the PRINZING Company. It is not allowed, neither entire, nor partially duplicate it, publish it or for unauthorized using in function of competition, and not to inform others. Deliberate infringements against this will be prosecuted.

1.2. Intended using

The „Electronic Control Comfort“ is only allowed to be used, to control drive winches for wire rope dung removal systems.

It is not allowed to use the comfort control for other operation purposes. Without a written approval of the Peter Prinzing GmbH, it is not allowed to use the electronic control Comfort with other motor types or drive winches as stated in the technical data or an using which not correspondents with the stipulations.

The operator of the comfort control has to know how to work with the control and about the possible risks. Inform yourself on this in the current legal regulations and stipulations, in the operating instruction or at the Peter Prinzing GmbH.

It is only allowed to use special equipment and additional controls with the comfort control which are stated in the order confirmation or in the technical data.

Not allowed are arbitrary rebuildings and variances on the electronic control comfort because of safety related reasons! Changes on the hard- or software of the control are not allowed without permission of the Peter Prinzing GmbH.







ATTENTION!

If the electronic control Comfort is not used according to regulations, a secure operation can not be ensured. Improper use must be avoided. Not the manufacturer but the operator is responsible for personal injury and property damage, which results of misapplication!

Date:	20-11-2014	Data name:	esc300-2-v12a_EN	ESC300 (swv-1.06)
Author:	Heiko Lange	Pages:	72	© P. Prinzing GmbH - 89173 Lonsee-Urspring (Germany)

1.3. Used characters and symbols

In this operating instruction there might be the following symbols:

BA	=	Operating instruction
(x)	=	The numbers in the brackets refer to the details of the pictures aside
◀ / ▶	=	Preceded number refers to the figure aside
	=	Function available only after login (setter or service personnel)
	=	Information - important information, tips and information for the operation
	=	Attention - important information about the safety of the operating personnel and the machine
	=	Description/explanation of technical terms and designations
1. Text	=	Sequence
- Text	=	Numeration
>>> Text	=	Sequence of an act

1.4. Definition:

Drive winch

Motor driven drum to coil the drag rope, to pull a scraper over the walkway

Drive unit

A drive unit consists of two drive winches (optional one double winch) and is used to drive min. one dung scraper.

Alley

Means the walkway (optional two walkways) on which minimum one dung scraper is moving by a drive unit.

Home position

The position of the scraper, from where the automatic scraper drive starts and ends.

Teaching

Manual learning of a program cycle by order input on the remote during the scraper drive

Interval time

Time between the end of the last scraper drive and a new starting command

Parking position

Position of the scraper, to where the scraper moves after the end of the program 2. Thereby the scraper is parking in a distance to the end stop. INFORMATION! - Parking position is not home position! Consider the description on [page 41](#)

Cyclic operation

The move of the scraper happens stepwise (drive - pause - drive - pause - and so on)

Date:	20-11-2014	Data name:	esc300-2-v12a_EN	ESC300 (swv-1.06)
Author:	Heiko Lange	Pages:	72	© P. Prinzing GmbH - 89173 Lonsee-Urspring (Germany)

* Option / depends on design

Service: +49 (0) 7336 - 961018

1.5. Overview components of the electronic control Comfort ESC300

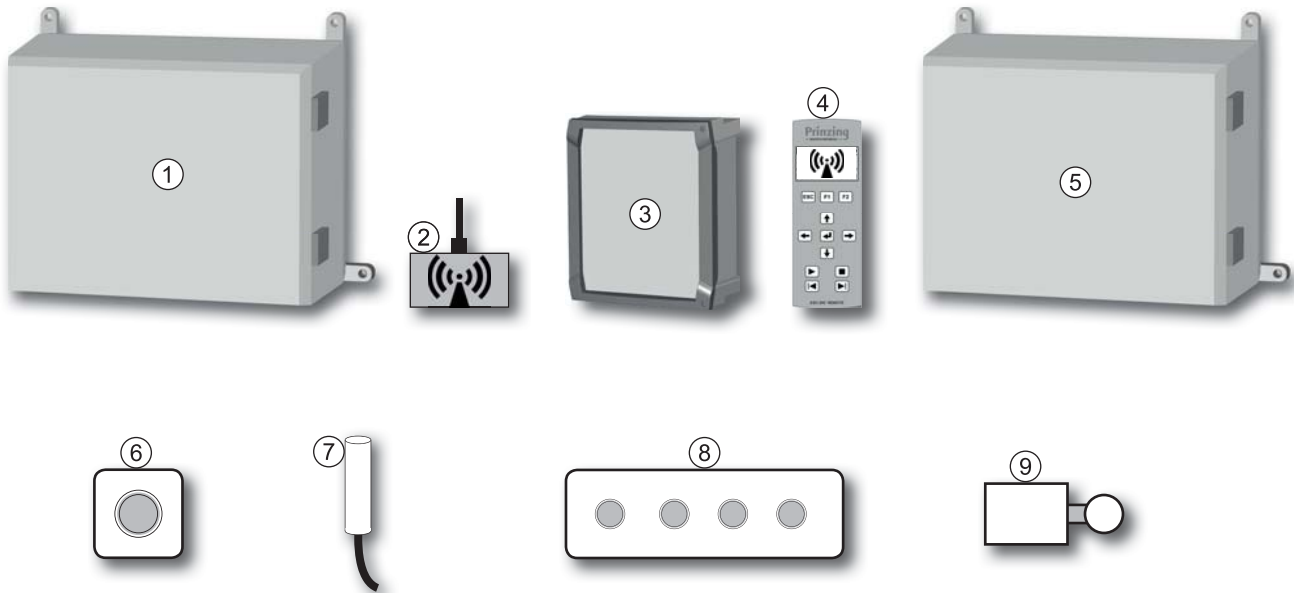

The electronic control Comfort ESC300 consists of the following components:

- (1) Basic unit ESC300 with
 - 1x power supply
 - 1x board *Control* with processor, SD-slot and software for the control. Inclusive connection for one alley with up to 2 drive winches.
 - up to 2x board *relay* to extend the control with one alley with each 2 drive winches
- (2) ESC300 *EXT-radio* >>> external transmitter- and receiver module for the communication between the *Remote* and the *Control*, wired. To strengthen the des radio signal, it is possible to connect max. 2 radio modules (in series or parallel)
- (3) ESC300 *Remote* >>> remote with display for settings and to operate with the control,
- (4) ESC300 *Charge* >>> charging station inclusive power supply for the operating control „ESC300 Remote“
- (5) EXP300 *Expansions module* >>> expansion for the system for alley 4 to 6. Consisting of max. 3x board relay
- (6) Emergency stop button (min. 1x per alley)
- (7) Temperature sensor

Optional equipment:

- (8) External quadruple pushbutton per alley, wired, functions: *start - stop - forward - backward*
- (9) End switch on the end of the walkway >>> for mechanical switch over and off of the scraper drive at the end of the alley

Date:	20-11-2014	Data name:	esc300-2-v12a_EN	ESC300 (swv-1.06)
Author:	Heiko Lange	Pages:	72	© P. Prinzing GmbH - 89173 Lonsee-Urspring (Germany)

1.6. Functions of the electronic control Comfort

By the electronic control Comfort you are able to regulate the sequence and the functionality of your dung removal system. By the control, the motors and the rope winches will be activated and monitored. It is possible to control up to 6 drive units (alleys), independently of each other. The check on the scraper movement happens by voltage- and time monitoring of the single motors.

Settings and operation with the control happens by a remote with graphic display. The control of the dung removal system can be manual or automatically.

The manual control happens directly by the push button (on the remote or external push button*). Thereby the scraper can be moved forward or backwards and the automatic can be started or stopped.

The automatic mode (automatic) of the control can be started manual, auto-scheduled by a timer or temperature-controlled by a temperature sensor. During the automatic, it is possible to choose between 4 programs, which program have to start automatically. These 4 programs are...

- Program 1 (P1) with standard sequence (forward/backward)
- Program 2 (P2) with predefined settings (animal detection and cyclic operation before the drop down/end)
- Program 3+4 (P3, P4) individual programmable programs by teaching² (scraper move free adjustable)

Additional there are the following functions on the control:

- Automatic detection of the connected drive units
- Voltage control and auto correction of the breaking currents when there are voltage fluctuations (e.g. when there is a photo voltaic -system)
- Manual deactivating of drive units (alleys) without data loss
- Automatic program start by a time table (timer) with 24 starting times/alley
- Antifreeze and freeze protection ba an automatic program start when the temperature falls below a value (freeze operation)
- Automatic adjustment of the starting intervals during the freeze operation when the temperature falls/increases
- One way operation per each starting impulse for walkways with slatted floor
- Using the scraper as a cow driver by manual auto scheduled operation by the function „drive“
- Signal output for an additional control (e.g. cross transport)
- Journal function, update and data backup with SD-memory card
- Emergency operation in case of system failure by manual control of the scraper by a push button on the board



TIP

By elongation, dirt or one side coiling of the traction rope on the drum, the position of the scraper may change slightly. For an accordingly function of the scraper system you should mount min. one scraper stop (on the home position). Thereby it is possible to reference the scraper position of each drive.

We would not recommend a operation without even one scraper stop. If you want to reduce the load of the traction rope by a scraper stop, use the end switch to switch over or -off the scraper drive.

One drive unit (for one walkway) consists of

- Minimum 1 scraper
- Maximum 2 wire rope winch

The drive unit will be described as alley in the operation instruction!

Teaching = Manual learning of a program cycle by order input (forward - backward - stop) on the remote during the scraper drive.



Date:	20-11-2014	Data name:	esc300-2-v12a_EN	ESC300 (swv-1.06)
Author:	Heiko Lange	Pages:	72	© P. Prinzing GmbH - 89173 Lonsee-Urspring (Germany)

* Option / depends on design

2. Assembling and connection



INFO

Consider during the assembling, that there is a stable radio connection between the control and the Charge with the remote.

The radio connection depends on the environment of the system. Armoured concrete walls, metal matrix, steel beams, fodder mixing wagons or other obstacles might attenuate the signal!

Consider the following points when mounting the components (equipment).

- Mount the control on a central, accessible place on a level surface.
- Into the feed line has to be mounted a main switch in a striking distance to the control.
- The charge module with the remote can be mounted independent to the position of the control ESC300 (e.g. in the stall).
- Mount the external radio module as central as possible in the operation area of the dung removal system, in a height of min. 2,5 m. Armoured concrete walls and metal structures might attenuate the signal!
- The equipment should not be exposed to extremely heat, cold or extreme thermal fluctuations.
- Protect the equipment of splash water or direct insolation.
- Mount all necessary screwing (enclosed) and close after assembling all coverings and not used openings on the equipment.
- If it is possible, mount the emergency stop button unapproachable for the animals (possible errors), viewable and accessible. According to the local conditions, you have to mount several emergency stop buttons.
- Use only allowed cables and lines and do not exceed the maximum length of the lines.
- Remove the battery protection film on the backside of the **REMOTE** before first using (pull the protection film out of the battery case!)

2.1. Assembling the control ESC300

Mount the control ESC300 by the delivered mounting straps (fig. 10/2) on a firm surface. Insert the cable only from the bottom of the control.

Connect on the control ESC300:

- Power feed line (400 V / 3~/PE, from the main switch).
- External radio module
- Motors rope winches for alley 1 - 3
- Emergency stop buttons
- Temperature sensor
- External push buttons* for alley 1 - 6
- End switch* (mechanical or inductive) for alley 1 - 3
- Contact for error messages*
- Contact for cross transport*

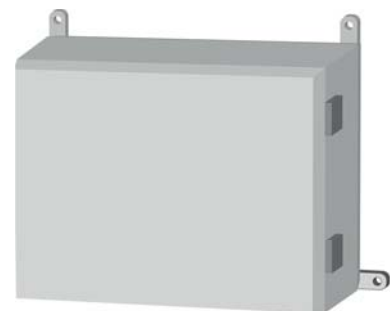

▲ 10/1
ESC300
Measurements: 400 x 300 x 180 mm



▲ 10/2
Mounting strap

Date:	20-11-2014	Data name:	esc300-2-v12a_EN	ESC300 (swv-1.06)
Author:	Heiko Lange	Pages:	72	© P. Prinzing GmbH - 89173 Lonsee-Urspring (Germany)

2.2. Assembling the charge ESC300

Mount the *Charge* in the radio range of the ESC300. Fix the *Charge* by the 4 fixing holes in the box.

Insert the cable for the power supply from below. On the *Charge* the *Remote* fixed and load.

On the ESC300 charge will be connected:

- A separate power feed line 230 V / 1~.



▲ 11/1
ESC300 Charge incl. Remote
Meas.: 234 x 264 x 90 mm

2.3. Assembling the radio module

Mount the radio module...

- in the centre of your range of movement with the remote, beginning from 2,5 m height
- protected against clamminess as for example rain, splash water or similar

Do **NOT** mount the radio module...

- on armoured concrete walls or on steel structures or in a radius of approx. 1 m to conducting metallic surfaces (cable lines, walls, doors)
 - in direct range to other modules which are working with radio signals (WLAN router, mobile phones, other radio stations)
- Hereby you might have errors because of interference or electrostatic screen



▲ 11/2
External radio module
Meas.: 98 x 64 x 38 mm

Fix the radio module over the fixing holes in the box in a way, that the cable inlet is below. Cable-type and -length see [page 14](#)

2.4. Assemble the control Expansion for alley 4 - 6

Mount the control Expansion EXP300 by the delivered mounting straps (fig. 10/2). Insert the cable only from below.

Consider the cable types and the max. length of the lines (see [page 14](#))

On the control EXP300 will be connected:

- the power feed line (400 V / 3~ / PE, from the main switch).
- the data bus ESC300 <-> EXP300
- the motors of the wire rope winch for alley 4 - 6
- End switch* (mechanical or inductive) for alley 4 - 6

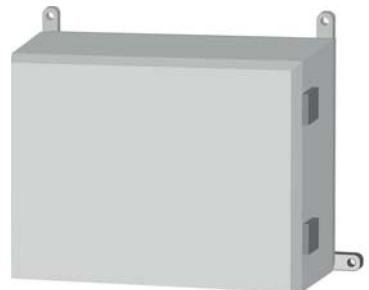

▲ 11/3
EXP300
Meas.: 400 x 300 x 180 mm

2.5. Assemble the temperature sensor

You need the temperature sensor for the function „freeze operation“.

Mount the temperature sensor ground level and protected of direct insolation or other heat radiation.

Consider during the assembling the **maximum length of the line of 10 m.**



▲ 11/4
Temperature sensor

Date:	20-11-2014	Data name:	esc300-2-v12a_EN	ESC300 (swv-1.06)
Author:	Heiko Lange	Pages:	72	© P. Prinzing GmbH - 89173 Lonsee-Urspring (Germany)

* Option / depends on design

2.5.1 Assembling example for the control and its components

ATTENTION ! - The positions of the components are an example and not binding!

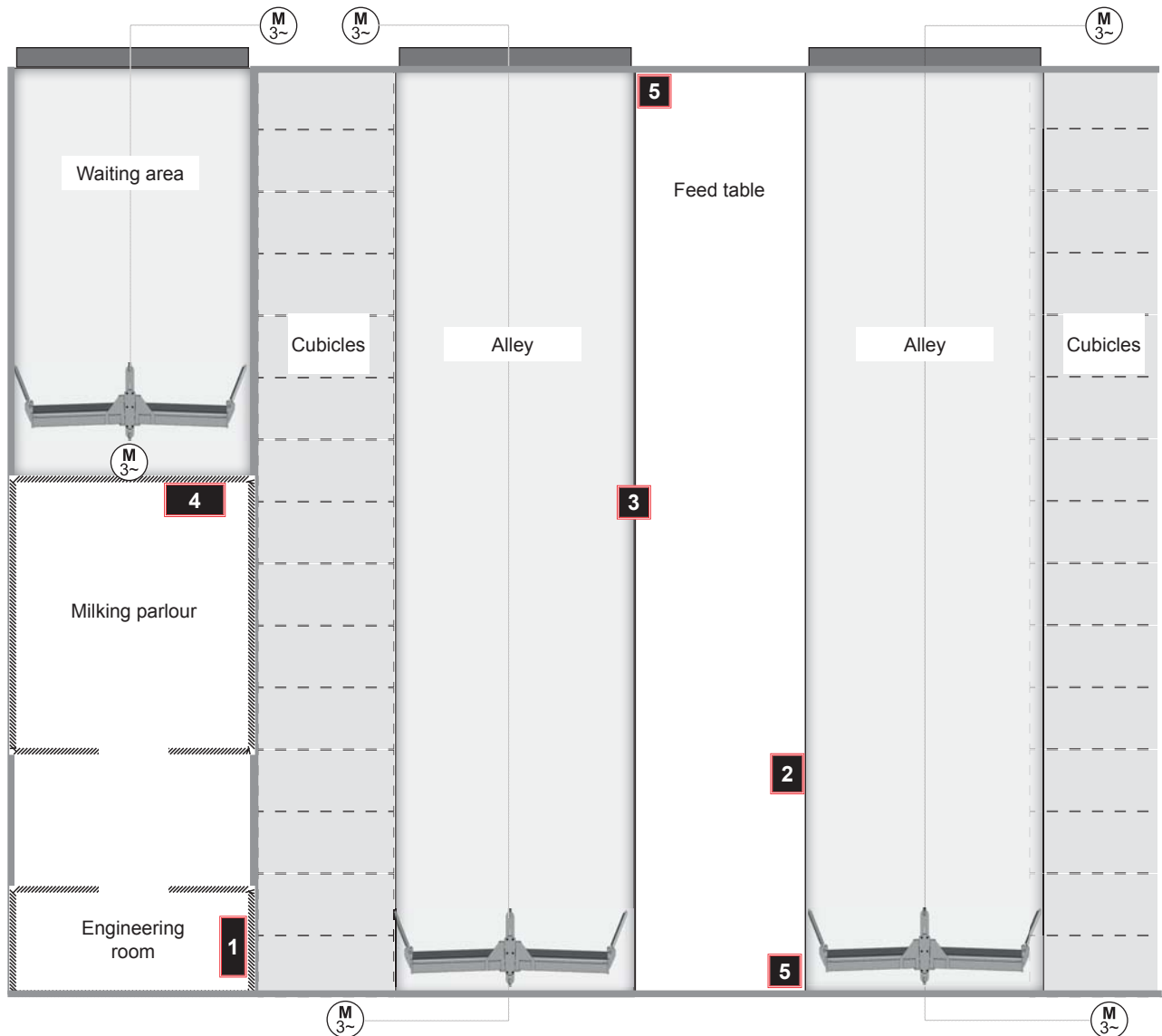

- (1) Control ESC300 and main switch, for alley 4...6 you need an additional control EXP300
- (2) ESC300 Charge with ESC300 Remote (accessible position in the stall for the operator)
- (3) External radio module (height > 2,5 m)
- (4) External push button* e.g. for the function „drive“
- (5) Emergency stop button, mount minimum one emergency stop button per alley. We recommend a emergency stop button round danger areas (e.g. wall openings, passages, drive winches), viewable and easy to mount .

Date:	20-11-2014	Data name:	esc300-2-v12a_EN	ESC300 (swv-1.06)
Author:	Heiko Lange	Pages:	72	© P. Prinzing GmbH - 89173 Lonsee-Urspring (Germany)

2.6. Electrical connection

The electrical connection of the control is only allowed to do by an authorized electronic specialist!
 Inform yourself about the connected load of the control and the components before assembling. For the electrical connection of the control and all of its components apply the current statutory provisions and operational stipulations (e.g. VDE 0100, EN 60204-1/VDE 0113 part 1)



ATTENTION

*Before connecting the control and during repair works on electric components of the system switch the main switch of the control always on „0“ (OFF)!
 Even when the main switch is switched off, the bushing clamps and the main switch are energized!*



Info

*We assume no liability for damages resulting from wrong, unprofessional or non approved electrical connections on the machine! To certificate a professional installation of the electric system, the executing electrician has to provide an acceptance report / inspection sheet.
 You can find an electrical connection plan for the control enclosed to this BA and in the packing of the control.*

Important information about the power supply of the control:

- The power supply for the entire control has to be lead over a shared main switch.
- It is **not** allowed to connect the feed line of the EXP300 directly to the ESC300. Connect the feed line of the EXP300 with the main switch, or use a conduit box.
- The charge will be connected self dependent from the control ESC300 (230 V/1~).
- Lines with a cross section of max. 2,5 mm² can be connected (see scale [page 14](#))

The following connected voltages are necessary for a failure-free operation:

- ESC300 (with control + relay) - **400 V / 3~ / PE / 50 Hz** (no neutral wire)
- EXP300 (with relay) - **400 V / 3~ / PE / 50 Hz** (no neutral wire)
- Charge - **230 V / 1~ / PE-N**

Mount the emergency stop button:

Mount per walkway minimum one emergency stop button. By using several emergency stop buttons and an effective positioning you are able to increase the safety of your dung removal system.

Mount the emergency stop buttons...

- on a accessible position, and also reachable for smaller persons (e.g. children)
- round danger areas (e.g. wall openings, gates, passages, dropping, drive winch)
- inaccessible for animals



ATTENTION!

If there is not minimum one emergency stop button connected on each alley, it is not allowed to start the operation of the dung removal system!

Date:	20-11-2014	Data name:	esc300-2-v12a_EN	ESC300 (swv-1.06)
Author:	Heiko Lange	Pages:	72	© P. Prinzing GmbH - 89173 Lonsee-Urspring (Germany)

* Option / depends on design

Service: +49 (0) 7336 - 961018

2.6.1 Cable types, line length and cable cross section



Component	Recommended line type	Min. number of leads	Voltage	Max. length
Feed line ⁽¹⁾ to the main switch	NYM 5 x 1,5 (2,5) mm ²	4	400 V / 3~ / 50 Hz	---
Feed line ⁽¹⁾ to the ESC300 from the main switch/ conduit box	NYM 5 x 1,5 (2,5) mm ²	4	400 V / 3~ / 50 Hz	---
Feed line ⁽¹⁾ to the EXP300 from the main switch/conduit box	NYM 5 x 1,5 (2,5) mm ²	4	400 V / 3~ / 50 Hz	---
Motor wire rope winch	NYM 5 x 1,5 mm ²	4	400 V / 3~ / 50 Hz	150 m
Emergency stop button ⁽²⁾	NYM 3 x 1,5 mm ²	2	24 V DC	150 m
End switch mechanical (option)	LiYCY 2 x 0,5 mm ² ROHS	2	24 V DC	150 m
End switch proximity switch (option)	LiYCY 3 x 0,5 mm ² ROHS	3	24 V DC	150 m
External operating keys (Option)	LiYCY 12 x 0,5 mm ² ROHS	6	24 V DC	100 m
Temperature sensor	NYM 3 x 1,5 mm ²	2	5 V DC	10 m
Data bus Expansion	LiYCY 5 x 0,5 mm ² ROHS	5	24 V DC	5 m
Radio module ⁽⁴⁾	LiYCY 8 x 0,5 mm ² ROHS	8	24 V DC	100 m
Transmitter / cross transport	NYM	2	max. 250V-AC/4 A max. 24V-DC/1 A	---
Safety shutdown board ⁽³⁾ - optional (release cable from the control)	NYM 3 x 1,5 mm ²	2	24 V DC	see emergency stop
Type of terminals on the control	Power supply + motors: plug-in screw AKZ 950 (PTR) max. 2,5 mm ² 24V-lines: spring pressure terminal block Wago 250-503506 max. 1,5 mm ²			

Consider the following information about the list:

- (1) Define the cable cross section corresponding the motor power and the length of the line. If necessary mount a conduit box after the main switch, to separate the feed line of the ESC300 and the EXP300.
- (2) Emergency stop button - we recommend to mount min. one emergency stop button per drive unit (alley)! The stated max. line length is the same as the cable length of the emergency stop line. By a series connection of the emergency stop controls, there will be an effective line length of maximum 300 m.
- (3) The controls release cable of the safety shutdown board to the ESC300 will be integrated into the emergency stop line circuit and must be, according to this, considered for the maximum line length of the emergency stop.
- (4) The used cable has to be screened and twisted. To increase the radio signal, it is possible to connect max. 2 radio modules (concatenated in series or parallel). The max. line length per radio module is 100 m. This equates for 2 concatenated radio modules a length of max. 200 m.

Information about the lines for low voltage up to 24 V DC

It is not allowed to install current circuit with low voltage and mains voltage in the same wiring system. Consider for low voltage lines, that there might be disturbances/malfuctions on the ESC300 by coupling of electromagnetic fields. Do not lay the low voltage lines together with the electric power line, but separated with a spacer. Keep the length of the lines as short as possible when there is low voltage.

Date:	20-11-2014	Data name:	esc300-2-v12a_EN	ESC300 (swv-1.06)
Author:	Heiko Lange	Pages:	72	© P. Prinzing GmbH - 89173 Lonsee-Urspring (Germany)

2.6.2 Connection of the electronic control - ESC300



INFO

Into the feed line of the control you have to integrate a main switch. Mount the main switch close to the control, so that it is accessible when doing maintenance works on the control.

The connection of the power feed line happens on the clamp *power-inlet* on the board *Control*, on the left side on the control cabinet (fig.15/1). The connection of the phases L1-L2-L3 happens by a plug with screw terminals (fig.15/3). The connection of **all** earth conductors happens on the earth connector-terminal strip on the left side of the box (fig.15/2). A neutral wire will **not** be connected. The power support of the boards relay 1+2 happens by the clamps *extension*. These connections are pre-assembled factory provided and are easily to exchange.

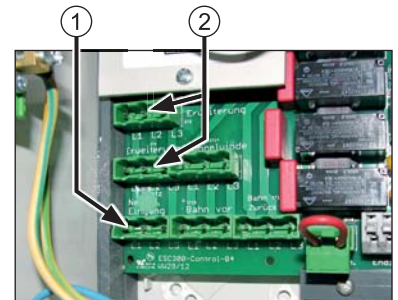

▲ 15/1 Power connection (1) power connection of boards relay (2)

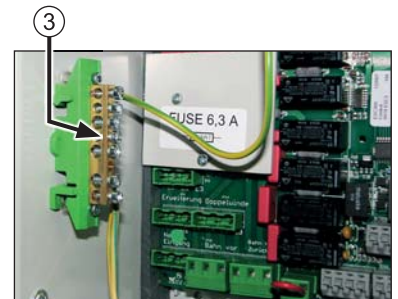

▲ 15/2 Earth connector-terminal strip (3)

2.6.3 Connection expansion module - EXP300

The power supply for the expansion module EXP300 happens, parallel to the ESC300, by the main switch in the feed line. The feed line for the EXP300 will be therefore connected parallel to the feed line of the ESC300 on the main switch. Alternatively it is possible to mount an distribution box after the main switch and connect there the feed lines. Connection examples see below - fig.15/4+5

The connection on the EXP300 happens, same as for the ESC300, by the clamp power supply and the earth connector-terminal strip (see description above chapter 2.6.2).



▲ 15/3 Terminal block



ATTENTION

It is not allowed to connect the power feed line for the expansion module by the clamps „extension“ on the ESC300.

The cable length for the data bus is maximum 10 m!

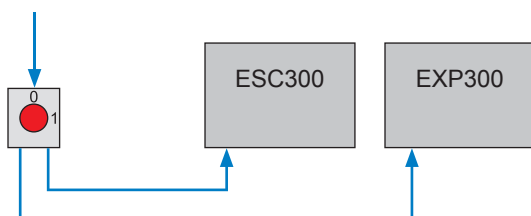

▲ 15/4 Power connection directly on the main switch

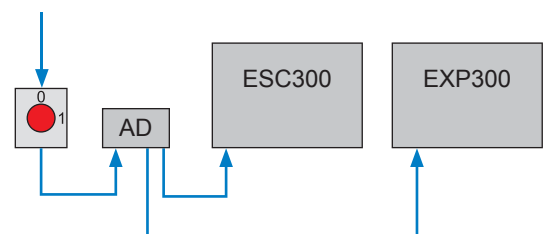

▲ 15/5 Power connection by the distribution box (AD)

Date:	20-11-2014	Data name:	esc300-2-v12a_EN	ESC300 (swv-1.06)
Author:	Heiko Lange	Pages:	72	© P. Prinzing GmbH - 89173 Lonsee-Urspring (Germany)

* Option / depends on design

Service: +49 (0) 7336 - 961018

2.6.4 Connection of the charging station ESC300 Charge

You need the charging station *Charge* to charge and store the *Remote*, and will be connected, independent of the control ESC300 to the power supply For the *Charge* you need a connection voltage of 230 V / 1~.

Connect the charging station ESC300 Charge:

1. **Open the transparent housing cover**
Therefore press the closing on the right side to the inside (fig.16/1).
1. **Loosen and extract all 4 screws (fig:16/2) on the base plate**
2. **Take the base plate out of the box**
Attention - Do not pull down the connected cable!
3. **Connect the feed line (230 V~) to the connection clamp (fig: 16/3)**
4. **Mount again the base plate and retighten the screws**



▲ 16/1
Open/Closing on the box



▲ 16/2
Fastening screws base plate

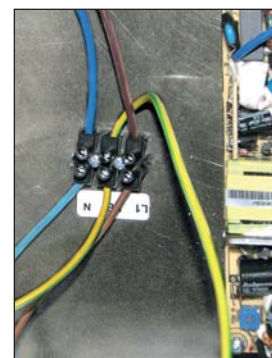

▲ 16/3
Connection clamps

2.6.5 Connection optional equipment (end switch, push button, signal transmitter)

Optional equipment is not included to the standard-delivery and have to be always ordered additionally. Inform yourself before connecting the additional equipment about the line length, -types and -cross sections in the installation plan. The following equipment can be connected to the control:

End switch >>> On each end of the walkway it is possible to mount an end switch for the switch over- and off of the scraper move without any load. You have to mount the end switch in a way, that the scraper can drive on easily and secure, to guarantee a correct function.

Push button >>> It is possible to connect a tethered quadruple push button for the control of the alley. By the push button you have the functions start - stop - forward - backward.

Signal transmitter >>> By optic or acoustic signal transmitters, errors or signals can be given.

If you have questions about the connection of the equipment, please contact our after sales service.

Date:	20-11-2014	Data name:	esc300-2-v12a_EN	ESC300 (swv-1.06)
Author:	Heiko Lange	Pages:	72	© P. Prinzing GmbH - 89173 Lonsee-Urspring (Germany)

3. Safety

The following safety advices are helping to avoid personal injuries and property damage. The operator of the dung removal system has to assure, that general safety advices and regulations are considered and kept. Persons who are responsible for the systems and the operation, as well as persons who are working with the dung removal system have to read and understand the entire operating instruction. Inform yourself before the commissioning of the control about the position and the correct condition of the safety- and protective devices.

Safety and protective devices are:

- Lockable main switch on the control
- Emergency stop button and safety shutdown board*
- Protective coverings and safety grid

3.1. General safety advices

1. **Before commissioning the system, after the assembling and repair- and maintenance works, check the entire assembling and the correct function of all safety and protective devices.**
2. **Before the maintenance and repair works on the dung removal system you have to switch off the control and protect against undesired switch on (e.g. lock main switch)**
3. **Check before every manual start of the scraper drive**
 - that there are no persons in the working area of the scraper
 - that the moving scraper means no danger for persons or animals

It is not allowed to:

- do repair and maintenance works on the system when it is switched on or during the operation
- arbitrary changes on the electronic control or on the components of the dung removal system
- operation methods, which derogate the security of the dung removal system.
- unattended operation of the system, if not all required safety and protective devices are working (see chapter 2.5).

Requirements provided by the customer:

To avoid danger areas between the scraper and solid building parts (e.g. wall breakthrough, doors, piles and parts of the housing), you have to keep a safety distance of minimum 500 mm over the scraper path. An under usage of this safety distance you have to clarify with the responsible Employer's Liability Insurance.

The legal requirements are fully applicable. (e.g. VSG 2.1 § 16)

Technical safeguards for danger areas are e.g. connecting blocks on the danger area, trip wires or limited movement control of the scraper.

3.2. Behaviour in danger situations

In visible or upcoming danger situations you have to:

- stop the system immediately by the emergency stop button, the STOP-button or by the main switch
- switch off the main switch and protect again undesired switch on (e.g. padlock)
- delete the danger cause or the error immediately

Only after deletion of the danger situation you can restart the operation and the system!

Date:	20-11-2014	Data name:	esc300-2-v12a_EN	ESC300 (swv-1.06)
Author:	Heiko Lange	Pages:	72	© P. Prinzing GmbH - 89173 Lonsee-Urspring (Germany)

* Option / depends on design

3.3. Danger areas of the dung removal system

Danger area	Danger	Safety measurements
Electric components	Electric shock	Close the system according to regulations Mount coverings Switch OFF the main switch before opening
Scraper	Danger of being crushed	Do NOT touch into the moving scraper Safety distance to the moving scraper
Wall openings Cross separations Staff passages	Danger of being crushed	Keep safety distance (> 500 mm over scraper) Limited movement control (tactile operation) of the scraper Mount the safety-connecting blocks
Drive rope	Risk of stumbling	Cover the rope or or guide it even with the ground Attach indicator plates
Drive winches and guide pulleys	Danger of being crushed Danger of permeate Risk of stumbling	Assembling according to regulations Attach and mount the protective coverings Check the safety distances

3.4. Danger by electric energy



ATTENTION!

Assembling-, connection- and repair works an den on electric components of the dung removal system are only allowed to be done by specialized personnel.

After assembling-, repair- and maintenance works on the electric system you have to check all safety devices. Note down the check corresponding the current valid regulations.



ATTENTION - Danger of electric shock!

When the main switch is switched off, there is still line voltage on the terminal clamps of the control and on the main switch. Before opening the electrical device, always switch off the main switch make sure that it can't be switched on!

Consider the following advices:

- Do not work on energized parts.
- Lay the cables and lines in a way, that no thermal, mechanical or electromagnetic strain can influence them. Consider the information in chapter „Assembling“.
- Mount all switches and coverings, close all openings according to regulations.
- Switch damaged or leaking electronic devices (control, switches, motors, and so on) strainless or replace them.
- Do the repair works on the electric parts only with approved tools.
- Replace damaged fuses by one of the same value

Date:	20-11-2014	Data name:	esc300-2-v12a_EN	ESC300 (swv-1.06)
Author:	Heiko Lange	Pages:	72	© P. Prinzing GmbH - 89173 Lonsee-Urspring (Germany)

3.5. Unattended operation (automatic) of the dung removal system

Unattended operation of the system means, that the connected rope winches turns self dependent and moves the respective scraper, by an automatic sent starting command of the control.

The respective starting command has to be set and started by the person who is responsible for the control ESC300. The following starting commands for an unattended operation are possible:

- Automatic start of a program by a schedule (timer)
- Automatic start of a program by temperature (freeze operation)

The following conditions have to be provided for an unattended operation of the dung removal system:

- Unauthorized persons (especially children) or animals are not allowed to enter the working area of the dung removal system
- You have to exclude all injury risks for the animals which may occur from structural conditions (consider the minimum height, use safety contact strips)
- All safety devices, especially the emergency stop have to be accessible and functional
- It is not allowed to do service-, maintenance- or cleaning works as well as other works (e.g. animal husbandry) in the working area of the dung removal system
- Keep the entries to the working area of the dung removal closed and mount information plates (automatic starting dung removal system) on the entries to the working area of the dung removal system

3.6. Danger of self-depended starting scraper

In the following situations the scraper starts automatically:

- „Automatic on“ (☰) >>> corresponding schedule from the starting position
- „Automatic on“ (☰) >>> corresponding schedule after manual stop in the walkway (to the next starting time)
- „Frost on“ (❄) >>> after reaching the switching on temperature in the set interval
- „Frost on“ (❄) >>> after „STOP“ in the set interval
- „Frost on“ (❄) >>> when „PAUSE“ after 600 sec



ATTENTION

Switch the main switch on “OFF” when doing repair- and maintenance works in the working area of the scraper. Thereby you are able to avoid danger which can occur by the automatic starting scraper.

3.7. Attach warning- and information signs

To increase the safety of your dung removal system and to avoid accidents, mount the following information signs:

- „Machine starts automatically“ (fig.19/1) >>> assemble on the drive winches. These warning signs you will get with the delivery of your system.
- „Automatic starting dung removal system“ >>> assemble on all entries to the working area of the dung removal system

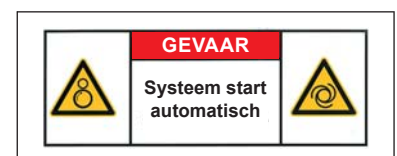

▲ 19/1
Warning signs

Date:	20-11-2014	Data name:	esc300-2-v12a_EN	ESC300 (swv-1.06)
Author:	Heiko Lange	Pages:	72	© P. Prinzing GmbH - 89173 Lonsee-Urspring (Germany)













* Option / depends on design

4. The radio controlled remote ESC300

Mode control during operation:

B = Operation (standard display)

E = Settings (in the menu)

1		B > Opens the menu E > Cancel an action during the insert E > Stepwise backward navigation in the menu E > Ends the teaching in program 3+4
2		E > „Cross transport. “ON“ - define position during teaching
3		E > Continue teaching E > Define end of the alley
4	 (Enter)	E > Open selection (submenu or menu item) E > Edit a chosen value E > Save an edit value B > Confirm/receipt a message (e.g. error)
5		B > Program change (upwards) E > Navigation in the menu upwards E > Rise a chosen value during the editing
6		B > Program change (downwards) E > Navigation in the menu downwards E > Lower a chosen value during editing
7		B > Change between alleys backwards E > Positioning the cursor in the menu
8		B > Change between alleys forward E > Positioning the cursor in the menu
9	 (Start)	Manual start of the automatic Starts the scraper move of the displayed alley (1-6) with the chosen program (P1...P4)
10	 (Stop)	Button STOP B > Stops the scraper move in the manual operation E > Stops the scraper move during the teaching (= pause time) B > Automatic: - 1x press in the automatic = pause - 2x press in the automatic = deletion
11	 (Back)	Button for the manual operation B > Moves the scraper back to the stop E > Starts the backward movement during the teaching of P3 + P4
12	 (Forw.)	Button for the manual operation B > Moves the scraper forward to the stop E > Starts the forward motion during the teaching of P3 + P4

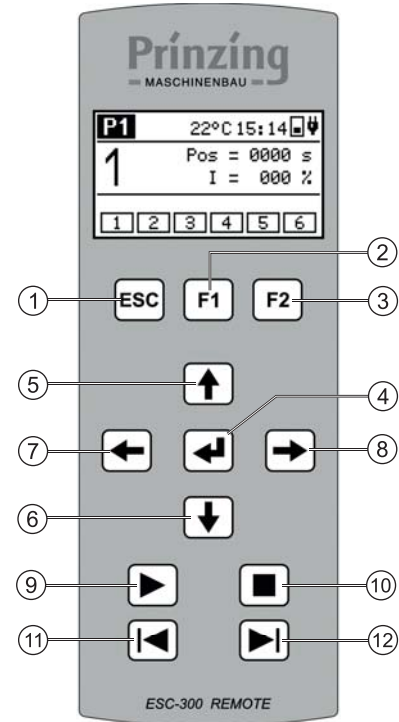

▲ 20/1
Radio controlled remote ESC300

Date:	20-11-2014	Data name:	esc300-2-v12a_EN	ESC300 (swv-1.06)
Author:	Heiko Lange	Pages:	72	© P. Prinzing GmbH - 89173 Lonsee-Urspring (Germany)

4.1. How to use the remote ESC300

Consider the following information about how to use the remote ESC300:

- Remove the battery protection film on the backside of the remote before the first using (pull protection film out of the battery case)
- Check the charge of the battery of the remote (charging symbol in the display ). If the charge state is below 50%, charge the remote in the charging station ESC300 completely. The charging time for an completely empty battery is approx. 12-14 hours.



TIP

To avoid interruptions by an empty battery, charge the remote always before commissioning and programming completely!

- If the batteries of the remote are empty, the remote has to be in the charging station (ESC300 Charge) to operate with the control.
- If the remote is not in the charging station (ESC300 Charge), the light intensity will be reduced after 30 sec. without using the buttons and after 5 min the energy control (Stand-by) starts. The display switches off in the Stand-by-Mode. **Press any button, to switch on the remote out of the Stand-by-Mode.**
- To avoid the discharging of the battery, put the remote into the charging station when you don't use it.
- Before using the remote, check the signal quality (radio controlled symbol in the display ). If you don't have enough signal move closer to the radio module or enlarge your system by an additional radio module.



INFO

Reinforced concrete walls, metal matrix, steel beams, fodder mixing wagon or other obstacles might level the radio signal!

- After switching on the remote (press any button) you can see the boot-display (Prinzing-Logo and „Please wait“). After approx. 3...5 sec. there will be the standard display (operation mode).
- The display lightning can be in different colours. They mean:
 - white > standard display, everything okay
 - yellow > there will be a warning message, e.g. „no radio contact“
 - red > there will be an error message, e.g. „error obstacle“
- If there will be an error or warning message the remote gives out a signal
- Keep the contacts on the backside of the remote always clean. Use applicable fluids for cleaning the contacts (e.g. contact cleaner spray, brush, cloth). Do, in no case, clean the contacts mechanical with sand paper, screw driver or similar.



Operation mode:

You can operate the scraper system by the remote. In the display you can see the standard display with current information (description see [page 22](#)). The control is operable.

Setting mode:

You can set the parameters of the control. In the display you can see the menu, sub menu or parameters (description see [page 22](#)).

Date:	20-11-2014	Data name:	esc300-2-v12a_EN	ESC300 (swv-1.06)
Author:	Heiko Lange	Pages:	72	© P. Prinzing GmbH - 89173 Lonsee-Urspring (Germany)

4.2. Display messages during the „operation mode“

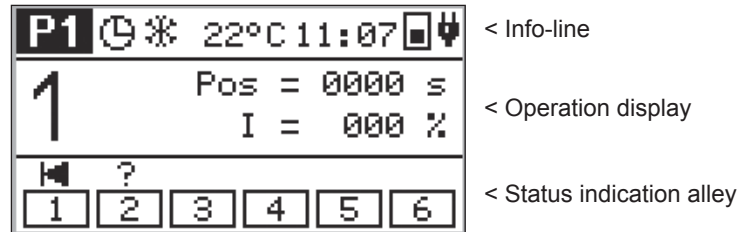

No.	Meaning	Display options
Info display	P1 Current chosen program for the manual start of the automatic f. Selection with arrows ↑ / ↓	P1 ... P4 = Programs 1...4 L = Program „learning“ active ≡ = Program „drive“ active
	Automatic operation (timer) is active	---
	Function frost operation is switched on	---
	°C Display of the current temperature	= Temperature sensor not connected
	11:07 Display of the time	---
	Charging condition of the battery in the remote During the charging the display pulsates.	discharged ... completely charged
	Remote is in the holder of the charging station	display of the radio signal strength of the remote outside the charging station
Operation display	1 Display of the chosen alley. Change between the alleys with ← / →	1 - 2 - 3 - 4 - 5 - 6
	POS Actual position (time in sec.) of the scraper after the last starting command	Display of information- and error messages as well as other information
	I Actual display of the current charging rate	
	Operation mode slatted floor is switched on	
	Function frost operation is active	
Status indication alley	Actual position of the scraper	= Scraper move switched off in rev. motion = Scraper move switched off in forw. motion = Scraper move in pause = Scraper was stopped manual = Teaching over > scraper stopped = Scraper position unknown = Info-/error message / = Scraper moves forw. / backw. L / L = Learning run forw. / backw. P / P = Scraper in parking position (front/back)
	Display of connected alley	... - = alley off - = alley active

Date:	20-11-2014	Data name:	esc300-2-v12a_EN	ESC300 (swv-1.06)
Author:	Heiko Lange	Pages:	72	© P. Prinzing GmbH - 89173 Lonsee-Urspring (Germany)

4.3. Display messages during the „setting mode“

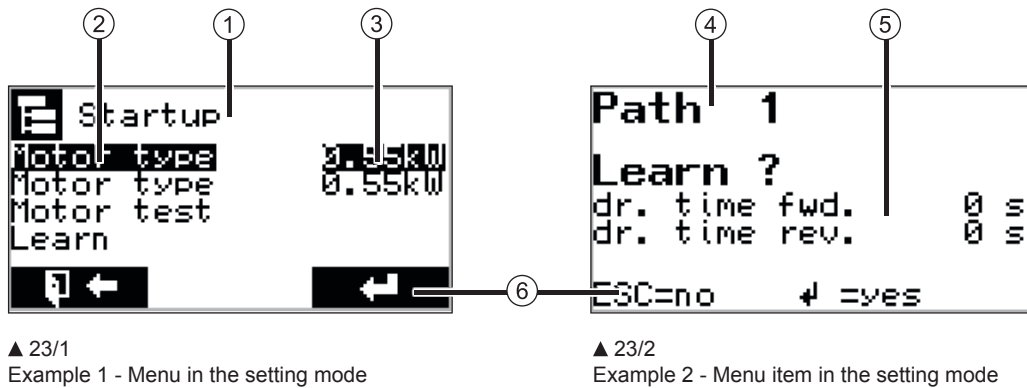

①	Description item or settings (parameter)
②	Adjustable parameters or submenu - selection with arrow ↑ / ↓
③	Editable parameters or values - for changing press ←> ↑ / ↓> ←
④	Description for chosen alley
⑤	Description of the chosen action and information e.g. for further operation
⑥	Information for possible action ESC or ESC = cancel/next without saving ENTER or ENTER = do an action/save settings

Consider the following information about the operation in the menu

- Open the menu with the **ESC BUTTON**
- Navigate in the menu with the arrow buttons
- A chosen a parameter will be always displayed inverted
- Press **ENTER** (**↵**) to open a menu item or to edit a parameter
- You can change editable parameters by the **ARROW BUTTONS** (**↑/↓**)
- Position the cursor by the **ARROW BUTTONS** (**←/→**)
- Always save all changed parameters by pressing **ENTER** (**↵**)
- Press **ESC** to end an action or to change one level back in the menu

Date:	20-11-2014	Data name:	esc300-2-v12a_EN	ESC300 (swv-1.06)
Author:	Heiko Lange	Pages:	72	© P. Prinzing GmbH - 89173 Lonsee-Urspring (Germany)

* Option / depends on design

Service: +49 (0) 7336 - 961018

5. Commissioning



INFO

To understand the function and the operation of the control, read the entire operating instruction before commissioning. Assure before commissioning:

- that the system was mounted corresponding the statutory provisions
- that all protection coverings have been mounted correctly
- that all electric components are connected correctly (specialist)
- that there are no danger situations for persons or animals during the operation of the system
- that the remote has been charged min. 50% (100% are recommended)

 Inform yourself before the commissioning of the control about the function of the buttons
 on the radio controlled remote! (see [page 20](#))

5.1. Switch on the control

1. Switch "ON" the main switch of the control ESC300

the control starts, the green LED on the front side of the control is blinking

2. Switch on the remote

Press any button on the remote. After finishing the starting sequence you can see the operation display (fig: 24/1)

3. Now the control is operable

Now you can start with the commissioning/set up the system or work with the already set system.

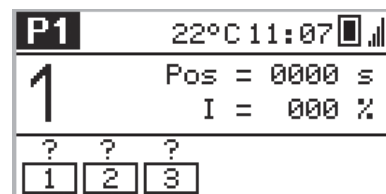

▲ 24/1
 Display of the operation mode after switching on the control

5.2. Set language - date - time

1. Press in the operation mode the button ESC on the remote

The main menu opens

2. Chose in the main menu „main settings“

The menu „main settings“ opens chose in the menu „main settings“ the parameter which you want to change (language, time, date)

3. Press ENTER (↵) to change the chosen parameter

4. Press the ARROW BUTTONS (↑/↓) to change the parameter

5. Press ENTER (↵) to save the changed parameter

6. Press ESC to leave the menu „main settings“

The display changes back to the main menu. Press the ESC button to leave the main menu.

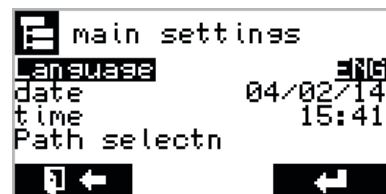

▲ 24/2
 Display setting mode, example: menu main settings



INFO

At the first commissioning and after a longer distance that you haven't switched on the control you have to set the time and the date!

There is NO automatic switch over between summer- and wither time!

Date:	20-11-2014	Data name:	esc300-2-v12a_EN	ESC300 (swv-1.06)
Author:	Heiko Lange	Pages:	72	© P. Prinzing GmbH - 89173 Lonsee-Urspring (Germany)

5.3. Switch off or on again the alleys

The electronic control is detecting automatically, how many alley modules (ESC300 relays) are connected with the „ESC300 Control“. Every alley which is connected with the „ESC300 Control“ will be shown on the display (fig: 25/1).

If you don't want to use one alley, you can deactivate this alley in the menu „main settings“. When deactivating the alley, all settings for this alley will be conserved. A deactivated alley will be displayed with a dashed line (fig: 25/2).

How to switch on/off the alleys:

1. Press in the operation mode the button **ESC** on the remote
The main menu opens
2. Chose „main settings“ in the main menu
The menu „main settings“ opens
Chose in the menu „main settings“ item „alley selection“
3. Press **ENTER** (↵) to open the item „alley selection“
4. Press the **ARROW BUTTONS** (↑/↓) to chose an alley
5. Press **ENTER** (↵) to edit the alley settings
6. Press the **ARROW BUTTONS** (↑/↓) to change the condition (On/Off)
7. Press **ENTER** (↵) to save the changing
8. Press **ESC** to leave the menu
Press the ESC button, till the operation mode will be displayed, or navigate to another menu item.

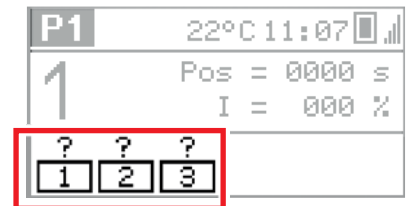

▲ 25/1
Alley display

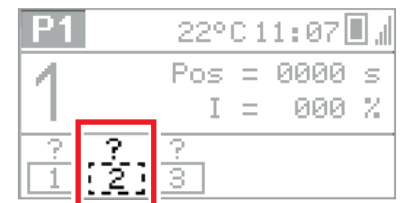

▲ 25/2
Deactivated alley

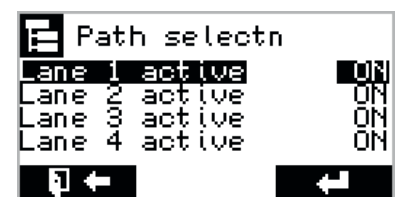

▲ 25/3
Menu item alley selection. Here you can switch ON or OFF the alleys

5.4. Commissioning of one alley

The commissioning of an alley is the basic requirement for the further operation of the dung removal system and has to be done for every single alley.

The following parameters have to be defined before the commissioning:

- Motor type >>> chose the nominal capacity (kW) for the connected motors
- Motor test >>> test the rotating direction for the connected motors
- Learning >>> the necessary breaking current of the motors and the driving time for forward and backward motion will be determined automatically and saved.

ATTENTION - The scraper has to be in home position before learning!

- Shutoff >>> the breaking current can be inserted or changed manual. A „learned“ breaking current should be only changed if there are problems with the scraper drive!

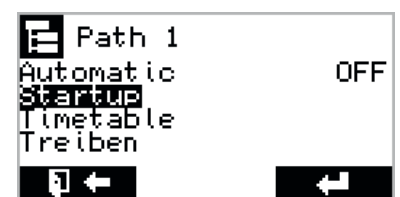

▲ 25/4
Menu item "Setup"

Date:	20-11-2014	Data name:	esc300-2-v12a_EN	ESC300 (swv-1.06)
Author:	Heiko Lange	Pages:	72	© P. Prinzing GmbH - 89173 Lonsee-Urspring (Germany)

Commissioning of one alley (alley 1...6):

1. Press in the operation mode the button **ESC** on the remote
The main menu opens
2. Chose in the main menu an alley, e.g. „alley 1“ (alley 1...6)
The menu „alley 1“ opens
Do the single settings, as described in the following chapters (5.4.1 ff).

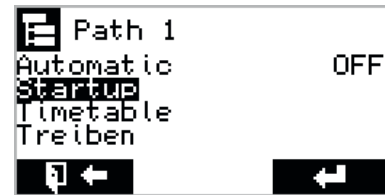

▲ 26/1
Menu item "Setup"



INFO

When you exchange, expand or change single components on the dung removal system (e.g. motors, alley length, or similar) you have to do the commissioning for the respective alley again.

When the commissioning is completely done, the control ESC300 with its programs P1 + P2 is operable (see chapter operation).



ATTENTION

Changes on the set parameters or incomplete or wrong settings on the parameters may lead to malfunctions of the control!

5.4.1 Chose motor type (nominal capacity)

Set the motor type (nominal capacity in kW) of the drive winches:

1. Chose in the main menu an alley (1...6)
Use the arrow buttons up/down for the selection
2. Chose in the menu alley (1...6) the item „setup“
Use the arrow buttons up/down for the selection
3. Press **ENTER** (↵) to open the „setup“
4. Use the arrow buttons, to chose a motor
Use the arrow buttons up/down for the selection
5. Press (↵) to edit the motor selection
6. Press the **ARROW BUTTONS** (↑/↓) to chose the motor capacity
7. Press **ENTER** (↵) to save the changes
8. Do the settings for both motors
When using a double winch adjust both motors in the same way!
9. Press **ESC** to leave the menu
Press ESC so oft, till the operation mode will be displayed, or navigate to another menu item.

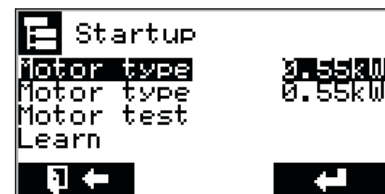

▲ 26/2
Menu item "Setup" - set the motor nominal capacity



Motor-nominal capacity

The motor nominal capacity you can find on the name plate of the respective motor on the drive winch.

Date:	20-11-2014	Data name:	esc300-2-v12a_EN	ESC300 (swv-1.06)
Author:	Heiko Lange	Pages:	72	© P. Prinzing GmbH - 89173 Lonsee-Urspring (Germany)

5.4.2 Do the motor test (rotating direction)

By the motor test, you are able to define the rotating direction of the drive winch.
Do the motor test...

- after a new installation of drive winches
- after repairing or changing of the drive motor
- after connection- or repair works on the motor feed line or its connection clamps

Do the motor test:

1. **Chose in the main menu an alley (1...6)**
Use the arrow button up/down for the selection
2. **Chose in the menu alley (1...6) the item „setup“**
Use the arrow buttons up/down for the selection
3. **Press ENTER (↵) to open the „setup“**
4. **Chose the parameter „Motor test“**
Use the arrow buttons up/down for the selection
5. **Press ENTER (↵) to open the item „motor test“**
6. **Test the rotating direction of the motors**
Button „forward“ = motor 1 - button „backward“ = motor 2.
7. **After ending the motor test press the button ESC to leave the menu**
Press the button ESC till the operation mode will be displayed, or navigate to another menu item.

```
Path 1
Motor test with:
=> FWD/RUSE
ESC=cont.
```

▲ 27/1
Menu item motor test



▲ 27/2
Button for the motor test on the remote
(1) - backwards, (2) - forwards



INFO

Check the rotating direction of the motor always directly on the winch (if necessary with 2. persons).
The motors will turn as long as the respective button will be pressed (dead man operation).
If its necessary, change the rotating direction of the drive winches on the connecting clamps of the control (only specialist!)

5.5. Do the program „learning“

For the automatic operation of your dung removal system it is necessary to do the program „learning“. During the „learning“ the control determines the optimal breaking current of the motors and the required driving time between the stops. Out of the learned values, the parameters for the programs 1+2 will be saved automatically.

Do the program „learning“ ...

- when commissioning the dung removal system
- after constructional changes on the dung removal system
- after changing the performance (abrasion, change the flooring, weather conditions) of scraper/walkway
- when you have several faulty switching on the system (obstacle, overload)



INFO

If you don't do the program „learning“, the dung removal system is not operable. The manual operation can only be used limited automatic is not possible.

Date:	20-11-2014	Data name:	esc300-2-v12a_EN	ESC300 (swv-1.06)
Author:	Heiko Lange	Pages:	72	© P. Prinzing GmbH - 89173 Lonsee-Urspring (Germany)

* Option / depends on design

Service: +49 (0) 7336 - 961018

Before you start the learning program, consider the following information.

- You can do the learning program on several alleys at the same time
- The scraper **has to be** in home position (at the stop) when starting the learning program!
- For the „learning“ you have to mount on each end of the walkway a stop. If you don't have this use „teaching“ for this walkway.
- Consider, that the scraper drives over the **complete** walkway. If the scraper drive was interrupted or stopped before reaching the end position, you have to repeat the learning program.
- Check before „learning“ the settings for the connected motor type (kW)!
- Check, before doing the learning drive, the walkway on obstacles den (edges, expansion gaps, screws in the guide rail, and so on) and remove them.
- During the learning program, the motors are driving with the maximum nominal capacity!
ATTENTION: Maximum drag force of the drive winch!!!
- For the programs P3 and P4 the „learning“ happens automatically during the teaching!

How to do the program „learning“:

1. Move the scraper into home position (stop or end position)
2. Chose in the main menu an alley (1...6)
Use the arrow buttons up/down for the selection
3. Chose in the menu alley (1...6) the item „setup“
Use the arrow buttons up/down for the selection
4. Press the button **ENTER** (↵) to open the „setup“
5. Chose in the menu „setup“ the item „learning“
Use the arrow buttons up/down for the selection
6. Press **ENTER** (↵) to open the menu item „learning“
7. Press **ENTER** (↵) to start the learning program

*Motor 1 starts the scraper move forward. The scraper drives one time over the entire walkway (forward and backward). The display changes back to the operation display. During the „learning“ you can see an „L“ on the display (▶L)
At the end of the scraper drive, the learning program ends and the learned values will be saved automatically.*

```

Path 1
Learn ?
dr. time fwd.    0 s
dr. time rev.    0 s
ESC=no         ↵ =yes
    
```

▲ 28/1
Menu item „learning“



TIP

An average quantity of dung in walkway during the learning is optimal for the result of the learning program.

If you have a new stall, you should repeat the learning program after 6-8 weeks. Then the scraper was moving long enough on the walkway that you can see if you maybe need a lower breaking current. Thereby you can preserve the tension rope.



▲ 28/2
Scraper is standing in the walkway (wrong)





▲ 28/3
Scraper is in home position (right)

Date:	20-11-2014	Data name:	esc300-2-v12a_EN	ESC300 (swv-1.06)
Author:	Heiko Lange	Pages:	72	© P. Prinzing GmbH - 89173 Lonsee-Urspring (Germany)

5.6. Programs on the control

For the automatic of the control you have for each alley 4 programs (P1 - P2 - P3 - P4). These 4 programs can be chosen individual for the manual and the automatic start of the scraper system. The standard setting on the control is program 1 (factory setting).

You are able to chose the programs on the following premises:

- (1) Program choice with manual start of the automatic on the remote by the  /  buttons
- (2) Program choice in the timer (schedule)
- (3) Program choice in the frost program

Consider the following information about how to use the following programs:

To use the programs 1-4 on each alley (1-6)

- for program 1+2 „learning“ must be done
- for program 3+4 „teaching“ must be done

If on one alley only the function „teaching“ for program 3 or 4 was done, then the program 1+2 are only available after doing the program „learning“.



INFO

Before using the programs the commissioning has to be done!

- motor settings
- learning program for P1 + P2
- teaching for P3 + P4

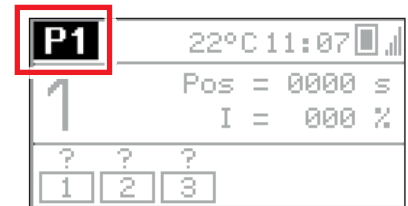

▲ 29/1

Program choice display program in the operation mode



▲ 29/2

Program choice in menu timer (schedule)



▲ 29/3

Program choice set in menu frost program

Date:	20-11-2014	Data name:	esc300-2-v12a_EN	ESC300 (swv-1.06)
Author:	Heiko Lange	Pages:	72	© P. Prinzing GmbH - 89173 Lonsee-Urspring (Germany)

* Option / depends on design

Service: +49 (0) 7336 - 961018

5.6.2 Program 1 (P1) - description

Program 1 (P1) is the basic program on the ESC300 and contains no additional setting options for the scraper drive. For the first using and after a reset program 1 is programmed on factory setting.

Sequence of the scraper drive with program 1 (see graphic 30/1):

Start > forward till the stop > turn > backward till the stop > stop

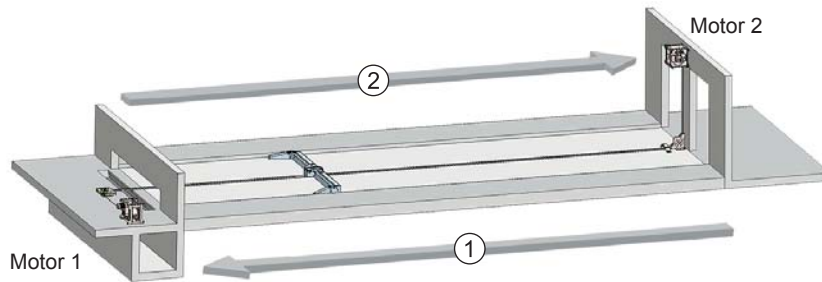

◀ 30/1
Graphic stall sequence program 1
(1) - forward
(2) - backward

5.6.1 Program 2 (P2) - description

By „learning“, all necessary parameters for program 2 will be determined and set automatically. After „learning“ the program is ready for operation **without** further settings. All parameters of program 2 can be individual adapted on demand (see [page 48](#)).

Program 2 (P2) contains the following options for the scraper drive:

- Animal- and obstacle detection up to the tactile operation
- Tactile operation (limited movement control) before the end of the alley

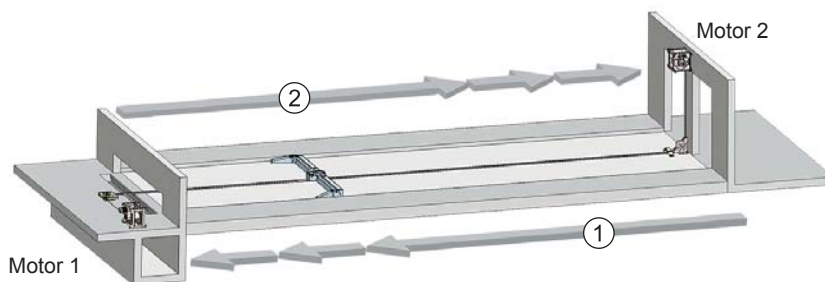

◀ 30/2
Graphic stall sequence program 2
(1) - forward
(2) - backward

Date:	20-11-2014	Data name:	esc300-2-v12a_EN	ESC300 (swv-1.06)
Author:	Heiko Lange	Pages:	72	© P. Prinzing GmbH - 89173 Lonsee-Urspring (Germany)





5.6.3 Program 3+4 (teaching) - description

The programs 3+4 are adaptive programs for the individual scraper drive. The creation of P3 + P4 happens, while the scraper is moving over the complete walkway by the remote. Thereby all scraper movements will be recorded and saved. Per comment (forw./backw.) there are 50 starting commands (forw., backw., pause) available.

The characteristics of 3+4 are:

- The scraper drive can start in any direction (forward- or backward motion).
- There can be several changes in direction.
- You don't have to program parameters. The creation of a program sequence happens only by the operating buttons on the remote.
- The starting command for a cross transport can be defined individual (button F1 during the teaching).
- Animal detection after the teaching up to the last stop-position before the stop/end of the alley.

Functions of the buttons on the „Remote“ during the teaching

	Starts the scraper move into the chosen direction (forw./backw.), till ... <ul style="list-style-type: none"> - you press the button STOP (pause) - the scraper drives against the stop, end switch or an obstacle
	Interrupts the scraper drive (pause). Position and duration will be saved as pause in the program.
	Defines the function „Cross transport on“ for the current scraper position. The button can be pressed during the scraper drive 1x each direction.
	<ul style="list-style-type: none"> - Press, after the scraper has moved against stop/end switch, to continue the teaching - Press, to define the end of the alley after pressing the STOP button
	Ends the teaching. The arrived positions will be automatically saved in the chosen program (P3 / P4).



INFO

- *Check before teaching, if the radio signal is sufficiently + strong enough (min. 1 line).*
- *Check before teaching, that the remote has load enough.*
- *During the teaching you have to press the respective buttons only short.*
- *Only the buttons which are necessary for the teaching are active.*
- *Single taught parameters can't be changed. For every single change on the program you have to restart the teaching!*
- *If the teaching was cancelled, you have to start from the beginning.*



TIP

- *The driving route of the scraper should be min. 50 cm between the pause*
- *The distance between the end stop and the scraper should be min. 40 cm for the last pause*
- *Between the last stop and the end of the alley, happens an animal detection in the completely taught program. Make this area very short when teaching (suggestion: last stop approx. 2 m before end of the alley/end stop)*

Date:	20-11-2014	Data name:	esc300-2-v12a_EN	ESC300 (swv-1.06)
Author:	Heiko Lange	Pages:	72	© P. Prinzing GmbH - 89173 Lonsee-Urspring (Germany)

* Option / depends on design

Service: +49 (0) 7336 - 961018



TIP

Start- and end position should be always on the same scraper position (home position) during the teaching.

If you don't want to end the teaching and the start position, you have to assure with the directly following program, that the start position of the following program corresponds to the end position of the last program.

Therefore it is possible to combine the programs P3 + P4.

How to teach a program (P3 or P4)

1. Move the scraper manual into home position
2. Chose for the respective alley program P3 or P4
3. Start the teaching with **FORWARD** or **BACKWARD**
Start the teaching always from the home position
4. Drive trough the walkway corresponding your requirements
Use the respective buttons on the remote to control the scraper drive. Consider the information and tips on [page 31](#)
5. Leave the menu after teaching by **ESC**
6. Now you can start the teached program manual (button **START**) or or allot to schedule/frost program

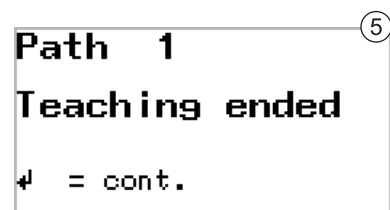
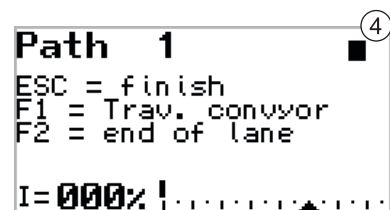
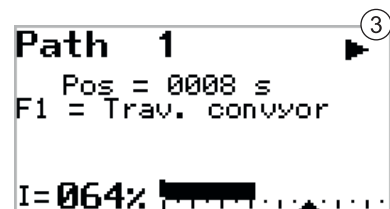
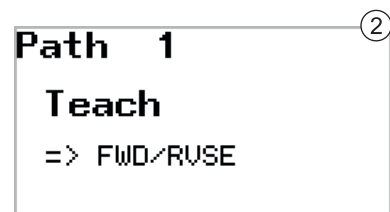

INFO

If you want to start a cross transport in the program, you have to press **F1** on the respective position during the teaching.

Display during the teaching (fir. right)

- (1) Selection „teaching“ in program 3 (P3)
- (2) Start teaching, or continue
- (3) Display during the teaching
- (4) Display at the end of the alley by a stop, end switch or stop
- (5) Display when teaching is over



TIP

If you need examples how to teach a program, please contact the PRINZING company.

Date:	20-11-2014	Data name:	esc300-2-v12a_EN	ESC300 (swv-1.06)
Author:	Heiko Lange	Pages:	72	© P. Prinzing GmbH - 89173 Lonsee-Urspring (Germany)

5.6.4 Set starting times in the schedule (Timer)

You need the schedule (Timer) for the automatic start of your scraper system corresponding defined starting times. It is possible to set up to 24 starting times each alley. Thereby the sequence of the starting times will be detected automatically. That means, you can delete or add starting times at any time, without considering the sequence. To each starting time you can attach a program (P1...P4).

That the schedule will be active, you have to set the automatic on „ON“. If the automatic is switched on for the respective alley, there will be the clock symbol on the display (fig.33/1).

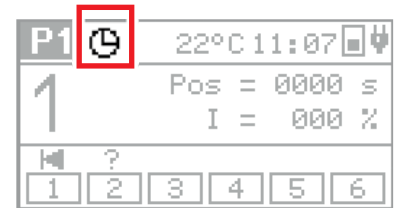

▲ 33/1
Display operation mode - symbol for „automatic ON“



INFO

*When inserting 00:00 hr the starting time will be skipped. Use therefor 00:01 hr.
For the duration of the active frost mode, the schedule will be deactivated.*

Set starting times in the schedule:

1. **Chose in the main menu „alley (1...6)“**
Use the arrow buttons up/down for the selection
2. **Chose in the menu alley (1...6) the menu item „schedule“**
Use the arrow buttons up/down for the selection
3. **Press ENTER (↵) to open the menu item „schedule“**
4. **Chose a „Time (01-24)“ in the schedule**
Use the arrow buttons up/down for the selection
5. **Press ENTER (↵) to edit the chosen „Time“**
- Press the arrow buttons (↑/↓) to change the value,
- Press the arrow buttons (←/→) to change the cursor position
6. **Press ENTER (↵) to save the „Time“**
7. **Press the ARROW BUTTON RIGHT (→) to change to the program selection**
8. **Press ENTER (↵) to edit the program selection**
9. **Press the ARROW BUTTONS (↑/↓) to chose a program**
Program 1 (P1) is set factory-made.
10. **Press ENTER (↵) to save the program selection**
11. **Press the ARROW BUTTONS (↑/↓) to change to the next „time“**
12. **Repeat the settings from point 4. till you have set all starting times**
13. **Press ESC to leave the menu**
Press ESC till there is the operation mode on the display, or navigate to another menu item

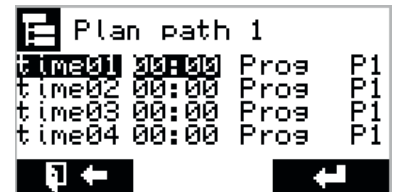

▲ 33/2
Menu schedule - starting time with program (P1-P4)

Date:	20-11-2014	Data name:	esc300-2-v12a_EN	ESC300 (swv-1.06)
Author:	Heiko Lange	Pages:	72	© P. Prinzing GmbH - 89173 Lonsee-Urspring (Germany)

6. Extended functions

By the extended functions *drive*, *slatted floor* and *frost mode* you have the possibility, to use your control even more multi-functional and effective. All extended functions can be used for each alley individually and in several times. You can chose the extended functions in the respective alley-menu.

6.1. Function drive

By the function „drive“ you have got the possibility to move a scraper with mounted driver gate* stepwise forward. The starting command for the scraper drive happens manual, by the button **forward** and has to be repeated for each scraper drive. After the starting command, the scraper moves forward for the duration of the set *driving time*. If the scraper moves against an obstacle during the driving time (animal, stop), the scraper move ends. By the button „back“ you move the scraper into home position (fig. 35/3)

If the function „drive“ is switched on, you can see the symbol for drive (⚙️) on the display.



INFO

Use the function „drive“ only, when you can see the walkway and the used scraper during the entire drive. Assure, before starting the scraper, that there are no persons in the working area of the scraper. If the function „drive“ is switched on, all other functions as automatic start by schedule and frost mode are deactivated.

For the function „drive“ you can set the driving time of the scraper during the drive.

Set the driving time for the function „drive“ :

1. Open the main menu (ESC) and chose an alley (1...6)

Use the arrow buttons up/down for the selection

2. Chose in the menu alley the item „drive“

Use the arrow buttons up/down for the selection

3. Press ENTER (↵) to open „drive“

The menu „drive“ opens

4. Chose in the menu drive „driving time“

Use the arrow buttons up/down for the selection

5. Press ENTER (↵) to edit the „driving time“

6. Press the ARROW BUTTONS (⬆️/⬆️) to set the driving time

7. Press ENTER (↵) to save the setting

8. Press ESC to leave the menu

Press ESC till the operation mode will be displayed. On the display will be the symbol „drive“.



▲ 34/1

Menu item „drive“ - set the driving time

Date:	20-11-2014	Data name:	esc300-2-v12a_EN	ESC300 (swv-1.06)
Author:	Heiko Lange	Pages:	72	© P. Prinzing GmbH - 89173 Lonsee-Urspring (Germany)

Switch on/off the function „drive“:

1. **Open the main menu (ESC) and chose an alley (1...6)**
Use the arrow buttons up/down for the selection
2. **Chose in the menu alley the function „drive“**
Use the arrow buttons up/down for the selection
3. **Press ENTER (↵) to open „drive“**
The menu „drive“ opens
4. **Chose „drive“ in the menu drive**
Use the arrow buttons up/down for the selection
5. **Press ENTER (↵) to edit „drive“**
6. **Press the ARROW BUTTONS (⬆/⬇) to switch ON/OFF „drive“**
7. **Press ENTER (↵) to save the setting**
8. **Press ESC to leave the menu**
Press ESC till the operation mode will be displayed. On the display you can see the symbol „drive“.

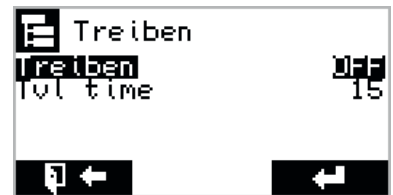

▲ 35/1
Menu item „drive“ - switch ON/OFF function „drive“

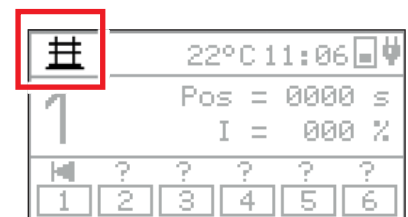

▲ 35/2
Display operation mode - display for „drive on“

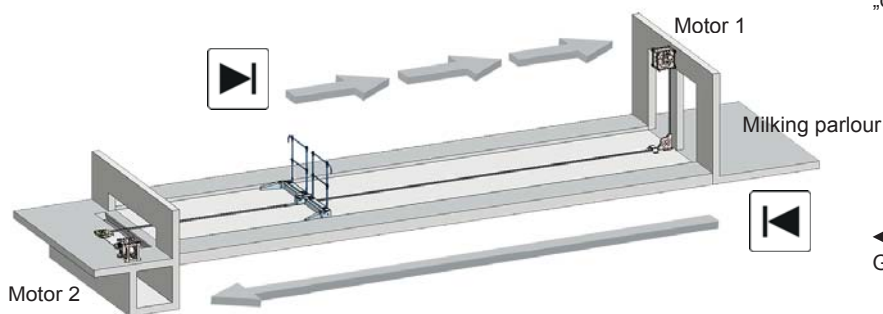

◀ 35/3
Graphic stall sequence during „drive“

6.1.1 Connect signal device for „drive“

On the control ESC300 you have got the possibility, that a signal device (signal-horn, lamp) will be driven on during the “drive”, and an optic or acoustic signal will be given. Therefore you have got the terminal clamps „cross transport“ and „error“. Depending on the seizure of the terminal clamps, you can activate a terminal clamp for the signal drive in the menu service. Information about to switch on the signal drive you can find in chapter „Service“ on [page 51](#).

Date:	20-11-2014	Data name:	esc300-2-v12a_EN	ESC300 (swv-1.06)
Author:	Heiko Lange	Pages:	72	© P. Prinzing GmbH - 89173 Lonsee-Urspring (Germany)

6.2. Function slatted floor

Use the function „slatted floor“, when using your scraper on slatted floor. When the function „slatted floor“ is switched on, the scraper moves only in one direction over the walkway to the stop on the other side during each program sequence. After the next starting command, the scraper moves into the opposite direction, and so on.



INFO

The direction of the slatted floor scraper after each starting command is always the opposite as the time before. When slatted floor is „on“, the driving directions „forward“ and „backward“ are always depending on the last driven driving direction.



▲ 36/1
Slatted floor scraper on slatted floor

Set the operation mode „slatted floor“:

1. Chose in the main menu an alley (1...6)
Use the arrow buttons up/down for the selection
2. Chose in the menu alley (1...6) the function „slatted floor“
Use the arrow buttons up/down for the selection
3. Press **ENTER** (↵) to edit „slatted floor“
4. Press the **ARROW BUTTONS** (↑/↓) to switch ON/OFF the function slatted floor
5. Press **ENTER** (↵) to save the changes
The operation mode „slatted floor“ is now set for the chosen alley.
6. Press **ESC** to leave the menu
*Press ESC till the operation mode will be displayed or navigate to another menu item.
The switched on operation mode „slatted floor“ will be displayed with the symbol (S) (see fig. 36/3)*



▲ 36/2
Menu alley 1 menu item slatted floor on/off

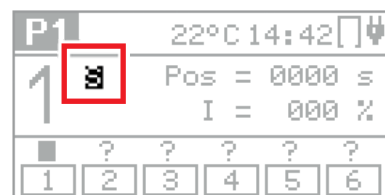

▲ 36/3
Operation display slatted floor „on“

Date:	20-11-2014	Data name:	esc300-2-v12a_EN	ESC300 (swv-1.06)
Author:	Heiko Lange	Pages:	72	© P. Prinzing GmbH - 89173 Lonsee-Urspring (Germany)

6.3. Function frost mode

To avoid that the scraper and/or the dung freezes on when the temperatures are very low, you have got the function „frost mode“ on your control.

You have to switch on the frost mode manual in the menu for the respective alley. Afterwards the control does the frost controlling automatically. If the set switch on temperature will fall below min. 1°C for the duration of the set delay time, the frost program will be **active** and starts the scraper move with the chosen program.

If the set temperature will exceed min 2°C for the duration of the set delay time, the frost mode will be **inactive** and there will be no starting command anymore. A started scraper move will be completed. After that, the control will be in the previous condition. The frost mode stays switched on (in attendance).

When frost mode is active, the starting times out of the schedule will be ignored!

For the frost mode there are the following switching status:

OFF >>> no frost mode

ON >>> If the frost mode is switched on for one alley, the symbol frost (❄) will be displayed in the info line (fig: 37/1).

Active >>> The switch on temperature was exceeded. The scraper move will be controlled by the frost mode. On the display you can see the symbol frost (❄) (fig: 37/2). The schedule is deactivated.

Function of the STOP button during active frost mode:

1x STOP = scraper move stops till the next starting impulse

2x STOP = scraper move stops for a pause of 600 sec.

ATTENTION! The scraper move starts automatically after that!

A stopped scraper move can be restarted by the START button.

If you want to stop the frost mode for a longer time, you have to switch off it in the menu „alley“. Because of that, always switch off the main switch when doing repair -or maintenance works!

Description of the adjustable frost mode parameters (fig: 37/3):

Switch on temperature (in °C)

Temperature, from which on the automatic start of the scraper move begins/ends

Interval time (❄) (in min)

Insert here the longest interval time. The interval time start when reaching the setting temperature (e.g. -1 °C)

Interval time (❄❄❄) (in min)

Insert here the shortest interval time for a temperature of -15 °C and lower.

Time delay (in min)

The switch on temperature have to be below or exceed for the entire adjusted time, so that the respective action (start or attendance) can be executed.

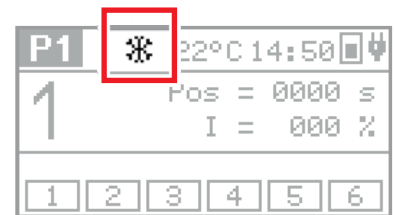

▲ 37/1
Operation display - Frost mode is switched ON

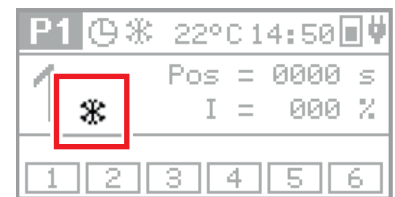

▲ 37/2
Operation display - Frost mode is active

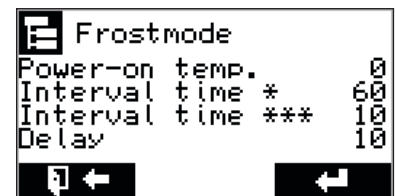

▲ 37/3
Menu „main settings“ Parameters for the frost mode

INTERVAL TIME

Time between the end of the last scraper move and start of a new one. When inserting different interval times, the number of intervals rise when the temperatures go low.

Date:	20-11-2014	Data name:	esc300-2-v12a_EN	ESC300 (swv-1.06)
Author:	Heiko Lange	Pages:	72	© P. Prinzing GmbH - 89173 Lonsee-Urspring (Germany)

* Option / depends on design

6.3.1 Set the parameters for the frost mode

You can set the parameters for the frost mode in the menu „main settings“. These parameters apply for all alleys.



TIP

For a linear adaption of the interval time corresponding the temperature chose in „interval time (*)“ a longer time and at „interval time (***)“ a shorter time, If you want to have interval times which are independent of the temperature, chose for both parameters „interval time“ the same value.

Set the parameters for the frost mode:

1. Chose in the main menu „main settings“
Use the arrow buttons up/down fro the selection
2. Chose in the menu main settings „frost mode“
Use the arrow buttons up/down fro the selection
3. Press **ENTER** (↵) to open the menu item „frost mode“
4. Chose a parameter (switch on temperature, interval time, or similar)
Use the arrow buttons up/down fro the selection
5. Press **ENTER** (↵) to edit the chosen parameter
6. Press the **ARROW BUTTONS** (↑/↓) to change the value of the parameter
7. Press **ENTER** (↵) to save the changes
8. Chose another parameter (point 4.) or end the setting
9. Press **ESC** to leave the menu
Press ESC till the operation mode will be displayed, or navigate to another menu item.

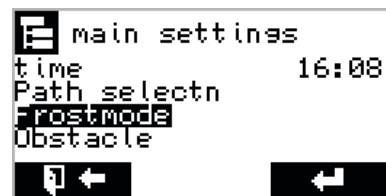

▲ 38/1
Menu „main settings“ chose „frost mode“

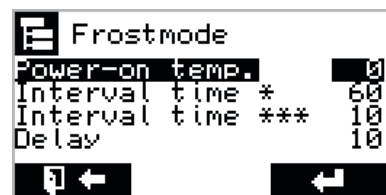

▲ 38/2
Menu „frost mode“ Parameters for the frost mode

Date:	20-11-2014	Data name:	esc300-2-v12a_EN	ESC300 (swv-1.06)
Author:	Heiko Lange	Pages:	72	© P. Prinzing GmbH - 89173 Lonsee-Urspring (Germany)

6.3.2 Set the frost mode for an alley

The frost mode...

- can be switched on/off for each alley separately
- can use for each alley another program (P1...P4)

Frost mode ON/OFF

Switches on/off the frost mode for the chosen alley.

Frost program type

Define a program created before (P1, P2, P3, P4), which should start when frost mode is active.

Set the function „frost mode“for one alley:

1. Open the main menu (ESC) and chose an alley(1...6)
2. Use the arrow buttons up/down fro the selection
3. Press **ENTER** (↵) to open an alley (1...6)
4. Chose in the menu alley (1...6) the menu item „frost mode“
Use the arrow buttons up/down fro the selection
5. Press **ENTER** (↵) to open the menu item „frost mode“
6. Chose „frost mode“
Use the arrow buttons up/down fro the selection
7. Press **ENTER** (↵) to edit the „frost mode“
8. Press the **ARROW BUTTONS** (↑/↓) to switch the frost mode on ON/OFF
9. Press **ENTER** (↵) to save the settings
10. Chose „frost program type“
Use the arrow buttons up/down fro the selection
11. Press **ENTER** (↵) to edit the „frost program type“
12. Press the **ARROW BUTTONS** (↑/↓) to chose a program
13. Press **ENTER** (↵) to save the settings
14. Press **ESC** to leave the menu
Press ESC till the operation mode will be displayed, or navigate to another menu item.



▲ 39/1
Menu alley 1 - select menu item „frost mode“



▲ 39/2
Menu item „frost mode“ - Set the frost mode ON/OFF

Date:	20-11-2014	Data name:	esc300-2-v12a_EN	ESC300 (swv-1.06)
Author:	Heiko Lange	Pages:	72	© P. Prinzing GmbH - 89173 Lonsee-Urspring (Germany)

* Option / depends on design

Service: +49 (0) 7336 - 961018

6.4. Set the obstacle detection

If the scraper detects an obstacle during it moves (e.g. a lying cow), it stops an the scraper moves back for a defined time (time reverse). After that...

- when the obstacle is not there anymore >>> the drive will be continued corresponding the program
- if the obstacle is still there >>> the scraper will try it again. If the „number of trials“ are over and the obstacle is still there, the program sequence will stop an on the display will be the message „error obstacle“



INFO

*The obstacle detection is integrated in the programs P2 to P4.
During the tact P2, as well as in the last tact in program P3 and P4 there will be no obstacle detection.*

Set the parameters for the obstacle detection:

1. Chose in the main menu „main settings“
Use the arrow buttons up/down fro the selection
2. Chose in the menu main settings „obstacle“
Use the arrow buttons up/down fro the selection
3. Press **ENTER** (↵) to open the menu item „obstacle“
4. Chose a parameter („time reverse“, „number trials“)
Use the arrow buttons up/down fro the selection
5. Press **ENTER** (↵) to edit the chosen parameter
6. Press the **ARROW BUTTONS** (↑/↓) to change the value
7. Press **ENTER** (↵) to save the changes
8. Chose another parameter or end the settings
9. Press **ESC** to leave the menu
Press ESC till the operation mode will be displayed, or navigate to another menu item.

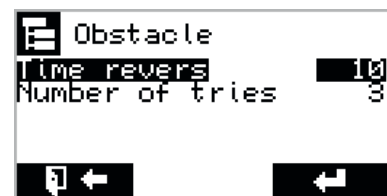

▲ 40/1

Menu item "Obstacle" - parameter for the obstacle detection in the programs P2...P4

Date:	20-11-2014	Data name:	esc300-2-v12a_EN	ESC300 (swv-1.06)
Author:	Heiko Lange	Pages:	72	© P. Prinzing GmbH - 89173 Lonsee-Urspring (Germany)

6.5. Parking position

By the function parking position, it is possible to park the scraper in any position on the walkway, after ending a program sequence. Thereby, the scraper will be moved back into the walkway for the set time **parking position** after reaching the home position (stop, time) (see fig: 41/1)

Consider the following information about the parking position:

- The function **parking position** is available for the programs P1 and P2
- During the scraper move between the stop and the parking position there is no animal-/obstacle detection
- If you set in **parking position** a driving time of > 3 s, you have to subtract this driving time in the program P2 at **time till tact** (forward).

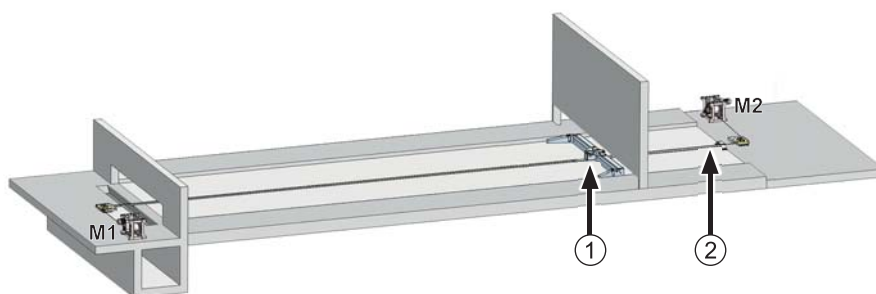

◀ 41/1
Graphic stall
(1) - scraper in parking position
(2) - home position of the scraper

Set the parking position for the flap scraper:

1. **Chose in the main menu an alley (1...6)**
Use the arrow buttons up/down fro the selection
2. **Press ENTER (↵) to open an alley (1...6)**
3. **Chose in the menu alley (1...6) „program 2“**
Use the arrow buttons up/down fro the selection
4. **Press ENTER (↵) to open „program 2“**
5. **Chose in the menu program 2 „settings REV“**
Use the arrow buttons up/down fro the selection
6. **Press ENTER (↵) to open „settings REV“**
7. **Chose in the menu settings back „parking position“**
Use the arrow buttons up/down fro the selection
8. **Press ENTER (↵) to edit „parking position“**
9. **Press the ARROW BUTTONS (↑/↓) to change the value**
10. **Press ENTER (↵) to save the changes**
11. **Press ESC to leave the menu**
Press ESC till the operation mode will be displayed or navigate to another menu item



▲ 41/2
Menu item „Settings REV“ - select function „parking position“



INFO
When using the function slatted floor (On), you can additionally set and use the parking position in the menu item „settings ahead“.

Date:	20-11-2014	Data name:	esc300-2-v12a_EN	ESC300 (swv-1.06)
Author:	Heiko Lange	Pages:	72	© P. Prinzing GmbH - 89173 Lonsee-Urspring (Germany)

6.6. Start the cross transport automatically

In the programs P2...P4 you have the possibility, to start a cross transport (or similar) automatically by a potential-free contact „cross drive“ on the ESC300. The starting impulse can be chosen for forward- and backward move. The duration of the starting impulse can be defined between 1...6000 sec. The cross transport can be started on each alley.

In the program P2 the cross transport will be started automatically with the first tact of the limited movement control (clocking).

In the program P3 + P4 you define by the F1 button in the item *teaching*, on which scraper position the cross transport should start.

The starting impulse happens corresponding the set **duration cross transport** in the menu *cross transport*.

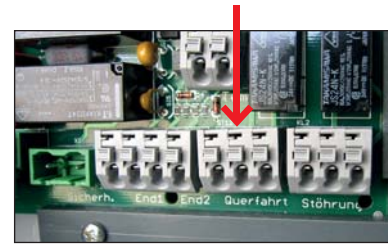

▲ 42/1
Terminal clamp cross drive

Set and activate the cross transport

1. **Chose in the main menu an alley (1...6)**
Use the arrow buttons up/down fro the selection
2. **Press ENTER (↵) to open an alley (1...6)**
3. **Chose in the menu alley (1...6) „cross transport“**
Use the arrow buttons up/down fro the selection
4. **Press ENTER (↵) to open „cross transport“**
5. **Chose in the menu cross transport „cross transport FWD/REV“**
Use the arrow buttons up/down fro the selection
6. **Press ENTER (↵) to edit „cross transport FWD/REV“**
7. **Press the ARROW BUTTONS (↑/↓) to change the value (On/Off)**
8. **Press ENTER (↵) to save the changes**
9. **Chose in the menu cross transport „duration cross transport“**
Use the arrow buttons up/down fro the selection
10. **Press ENTER (↵) to edit „duration cross transport“**
11. **Press the ARROW BUTTONS (↑/↓) to change the value**
Chose the „duration“ corresponding the chosen control. Only one starting impulse is possible (1 sec), or actuate the system for a time X.
12. **Press ENTER (↵) to save the changes**
13. **Press ESC to leave the menu**
Press ESC till the operation mode will be displayed or navigate to another menu item

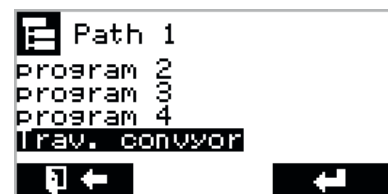

▲ 42/2
Menu alley - Selection menu item „cross transport“



▲ 42/3
Menu item „cross transport“ - set the signal time



INFO

If you want to actuate a cross transport with program P3 + P4, you have to press F1 during the teaching on the respective scraper position in forward/backward motion. Thereby you can define the starting time for the cross transport.



Attention

The cross transport will also start when frost program is active. Assure, that when it's very cold, that the cross transport is able to work without problems (not frozen).

Date:	20-11-2014	Data name:	esc300-2-v12a_EN	ESC300 (swv-1.06)
Author:	Heiko Lange	Pages:	72	© P. Prinzing GmbH - 89173 Lonsee-Urspring (Germany)

7. Operation with the ESC300

Before you start the operation with the control ESC300 you have to assure the following points.

- The system is completely mounted incl. all safety arrangements.
- The system was set up corresponding all legal statutory and operational provisions.
- The control was commissioned according to the rules (main settings, learning program).
- The operator of the control knows the dung removal system and knows about the functions and the operator buttons.
- The operator knows about the danger which may lead from the dung removal system.

Before operating with the control the commissioning must be performed (chapter 5)!

7.1. Manual operation with the electronic control ESC300

By the operator buttons on the remote ESC300 you can start the scraper manual. For the manual operation, the operation mode must be displayed (43/1.)

Functions for the manual operation:

Chose one alley:

Press the **ARROW BUTTONS** (← / →) to select one alley. The chosen alley will be displayed.

Chose a program:

Press the **ARROW BUTTONS** (↑ / ↓) to select a program. The chosen program will be displayed.

Scraper move manual forward:

Press the button **FORWARD** (►) to move the scraper ahead. The scraper moves up to the next stop, obstacle or till the button STOP was pressed.

Scraper move manual backward:

Press the button **BACKWARD** (◀) to move the scraper back. The scraper moves up to the next stop, obstacle or till the button STOP was pressed.

Start a program sequence manual (scraper in home position!!!):

Press the button **START** (►) to start the displayed program. The scraper moves corresponding the parameters which were set in the program.

Interrupt scraper move (pause) or end (stop):

With the buttons forward/backward for manual scraper move. Press **1x** the **STOP** button (■) >>> the scraper move ends

For automatic scraper move (program sequence) with button start. Press **1x** the **STOP** button (■) >>> the scraper will be interrupted (pause)
Press **2x** the **STOP** button (■) >>> the scraper move ends

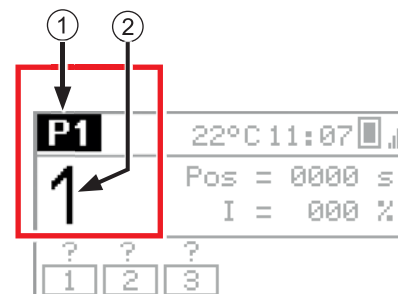

▲ 43/1
Display operation mode
(1) - display current program
(2) - display chosen alley

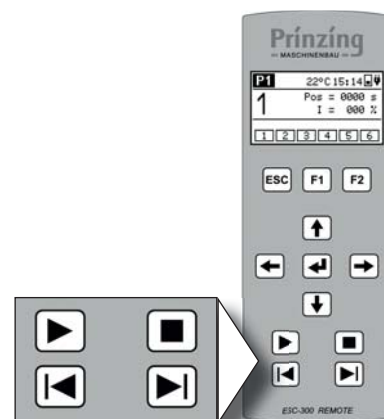

▲ 43/2
„Remote“ - Operator buttons for the scraper move

Date:	20-11-2014	Data name:	esc300-2-v12a_EN	ESC300 (swv-1.06)
Author:	Heiko Lange	Pages:	72	© P. Prinzing GmbH - 89173 Lonsee-Urspring (Germany)

* Option / depends on design

7.2. Automatic operation with the electronic control ESC300

In the *AUTOMATIC*, the start of the scraper happens automatically...

- corresponding a set time in the schedule (timer)
- corresponding a set temperature when frost mode is active
- corresponding a set interval time when frost mode is switched on and active
(all settings have to be done by the operator)



INFO

The automatic is only allowed, when all safety arrangements are fulfilled for an unauthorized operation of the system. It has to be assured, that dangers for persons or animals by the unauthorized scraper operation are excluded.

The automatic starts after a mains failure self dependent corresponding the set time. If in this case the scraper is not in home- or parking position, there might be an error message at the end of the walkway („error obstacle“)

For the automatic you have to set min. one starting time with program!

You have to start the scraper in the automatic always from the home position or from the parking position!

7.2.1 Automatic operation by schedule (Timer)

For the automatic by schedule, the respective alley:

- needs min. one starting time in the schedule
- the automatic must be set on „On“ in the menu alley

Switch ON/OFF the automatic:

- 1. Chose in the main menu an alley (1...6)**
Use the arrow buttons up/down fro the selection
- 2. Chose in the menu alley (1...6) the function „automatic“**
Use the arrow buttons up/down fro the selection
- 3. Press ENTER (↵) to edit the „automatic“**
- 4. Press the ARROW BUTTONS (↑/↓) to switch ON/OFF the automatic**
- 5. Press ENTER (↵) to save the settings**
- 6. Press ESC to leave the menu**
Press ESC till the operation mode will be displayed or navigate to another menu item.

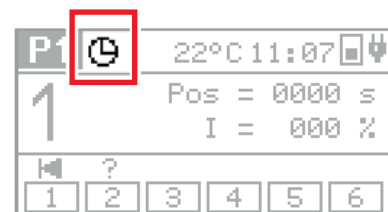

▲ 44/1
Operation display - symbol for automatic „ON“

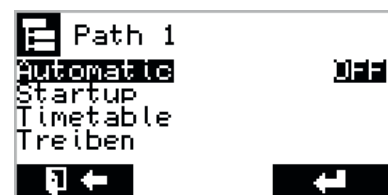

▲ 44/2
Menu alley 1 - switch automatic ON/OFF



INFO

If the frost program is switched ON, the automatic start by schedule will be ignored during the active frost mode (temperature exceeded).

Date:	20-11-2014	Data name:	esc300-2-v12a_EN	ESC300 (swv-1.06)
Author:	Heiko Lange	Pages:	72	© P. Prinzing GmbH - 89173 Lonsee-Urspring (Germany)

7.2.2 Automatic operation by frost mode

If the frost mode is switched on on the control, the scraper move will be started automatically, when the set temperature was exceeded.

The scraper move happens thereby corresponding the set program (P1...P4).

Inform yourself in chapter „extended functions > frost mode“ about the functions and settings of the frost mode.



INFO

If the frost mode is switched on and active, the schedule will be ignored.

If the frost mode is no longer active, the current program ends and the scraper move happens again corresponding the schedule (when automatic is „ON“)

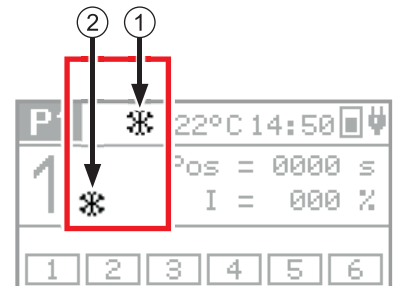

▲ 45/1

Operation display

(1) - symbol for frost mode „ON“

(2) - symbol for frost mode „active“

7.3. Operation of the control by external push button*

As an alternative to the *Remote* you can attach for each single alley an external push button. These external push buttons are equipped with each 4 push buttons (forward - backward - start - stop).

The functions of the push buttons are identic with the function of the buttons on the *Remote*.

Information about the connection of the external push button on the control you can find in the connection plan. Consider the allowed line lengths and -types (see [page 14](#)).



▲ 45/2

External quadruple push button

7.4. Switch over and off the scraper move by the end switch*

On the control, you can connect for each alley and each driving direction an end switch for the switch over and off of the scraper move. By the end switch, you can reach a powerless switch over and off of the scraper drive and thereby a lower-war operation of the system.

Mount the end switch in a way, that...

- it can't be released by animals
- it is protected against dirt

Information about the connection of the end switch on the control you can find in the connection plan. Consider the allowed line lengths and -types (see [page 14](#))..

Date:	20-11-2014	Data name:	esc300-2-v12a_EN	ESC300 (swv-1.06)
Author:	Heiko Lange	Pages:	72	© P. Prinzing GmbH - 89173 Lonsee-Urspring (Germany)

* Option / depends on design

8. Service

In the chapter service is described, how to...

- change parameter- and program settings
- ask for system information of the control
- find out and delete errors on the control/dung removal system

Consider the following information!

- Service works are only allowed to be done by specialized personnel and considering this operation instruction as well as the statutory and operational accident prevention regulations! Inobservance of the information and the regulations may lead to considerable personal injuries or damage to property!
- Use only original standard spare parts, which are from the manufacturer or allowed/released by the manufacturer when changing broken or damaged parts.
- When there are errors on the electric system (e.g. cables, motors) the fault finding and -deletion has to be done by a specialized electrician. Switch the main switch "OFF" when there are errors and contact our service. So you can avoid other possible damages on your dung removal system.
- Keep your control and all other electric components closed when you are not working on them. Use for repair works only allowed and checked electric tools!
- When doing unauthorized repair works on the electric parts (e.g. boards), your guarantee claim expires! For damages resulting out of non specialized connecting- and repair works on the control/dung removal system, we assume no liability.

Before contacting our service, note down the following...

- the exact description of your system (name plate on the box)
- serial number of the system (name plate on the /box/board)
- software-version (main menu > system information > software)
- ALL displayed messages



▲ 46/1
Name plate on the box

8.1. Change parameters and program settings

The parameters for the function of the control are adjusted factory-provided or determined by the function "learning" and saved automatically. All parameters are adjusted in a way, that an issue-free operation of the dung removal system is possible. The following parameters can be changed and adapted on your demands:

- the learned breaking current for motor forward and motor backward of alley 1...6
- parameters for the scraper drive on program 2 (P2)
- language, date and time (see [page 24](#))
- the motor type or the connected drive winch (see [page 26](#))



INFO

**Changing the parameters may lead to errors and problems on the dung removal system.
Do only change the parameters when you know about the consequences of your act.**

Date:	20-11-2014	Data name:	esc300-2-v12a_EN	ESC300 (swv-1.06)
Author:	Heiko Lange	Pages:	72	© P. Prinzing GmbH - 89173 Lonsee-Urspring (Germany)

8.1.1 Change the learned breaking current

The breaking current should only be changed, when you have several problems with the scraper drive (e.g. error obstacle) although repeatedly executed program „learning“

How to change the breaking current:

1. **Chose in the main menu an alley (1...6)**
Use the arrow button up/down for the selection
2. **Chose in the menu alley (1...6) the item „setup“**
Use the arrow button up/down for the selection
3. **Press ENTER (↵) to open the „setup“**
4. **Chose the parameter „Power-off FWD“/„Power-off REV“**
Use the arrow button up/down for the selection
5. **Press ENTER (↵) to edit „Power-off (FWD-forward/REV-backward)“**
6. **Position the cursor by using the ARROW BUTTONS (←/→)**
7. **Press the ARROW BUTTONS (↑/↓) to change the values**
8. **Press ENTER (↵) to save the changes**
9. **Press ESC to leave the menu**
Press ESC till the operation mode will be displayed or navigate to another menu item.

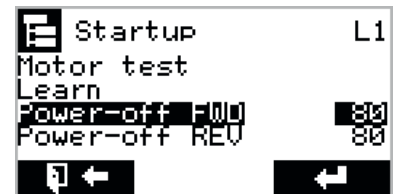

▲ 47/1
Menu item "Setup" - Settings for "Power-off FWD" (breaking current forwards)



ATTENTION

The maximum adjusting value of the breaking current is 115 %. When adjusting the breaking current on 100 % there might be the danger of thermal overload of the motor. If the adjustment under 100 % is not possible, do not work with the system (in emergency cases only short-term)



INFO

*If you set the breaking current below the „learned“ value (too low), there might be errors during the operation (scraper move will be interrupted).
If you set the breaking current higher than the „learned“ value (too high), the war of the system (e.g. rope) might rise.
You will reach an optimal result for the breaking current with the automatic learning program.*

Date:	20-11-2014	Data name:	esc300-2-v12a_EN	ESC300 (swv-1.06)
Author:	Heiko Lange	Pages:	72	© P. Prinzing GmbH - 89173 Lonsee-Urspring (Germany)

* Option / depends on design

Service: +49 (0) 7336 - 961018

8.1.2 Change parameter program 2 (P2)

By the function „learning“, the program 2 will be created with the following sequence:

Forward > time till cycling > pause > tact 1 > pause > tact 2 > pause > tact 3 > stop = change in directions
 Backward > time till cycling > pause > tact 1 > pause > tact 2 > pause > tact 3 > stop = end of the program

The following parameters can be changed for forward and backward motion:

- **Time till cycling** - will be automatically determined by the function „learning“
- **Cycle length** - driving time of the cycles (tact), factory provided = 15 sec
- **Pause duration** - pause between the cycles, factory provided = 5 sec
- **Number of cycles** - factory provided = 3 cycles
- **Parking position** - see manual [page 41](#)

Consider when adjusting the parameters for program 2:

- The total driving time of the scraper =: **time till cycling + number of cycles x cycle length**
- The **time till cycling** has always be smaller than the total driving time
- Chose the **number of cycles** and the **cycle length** in a way, that the programmed total driving time is longer than the factual driving time. So you can assure that the scraper is moving always till the respective stop
- The **number of cycles** should be min. „1“
- The **cycle length** should *not be smaller* than 10 sec.
- If you don't want a limited movement control (tact at the end of the alley), set the **pause duration** on „0“

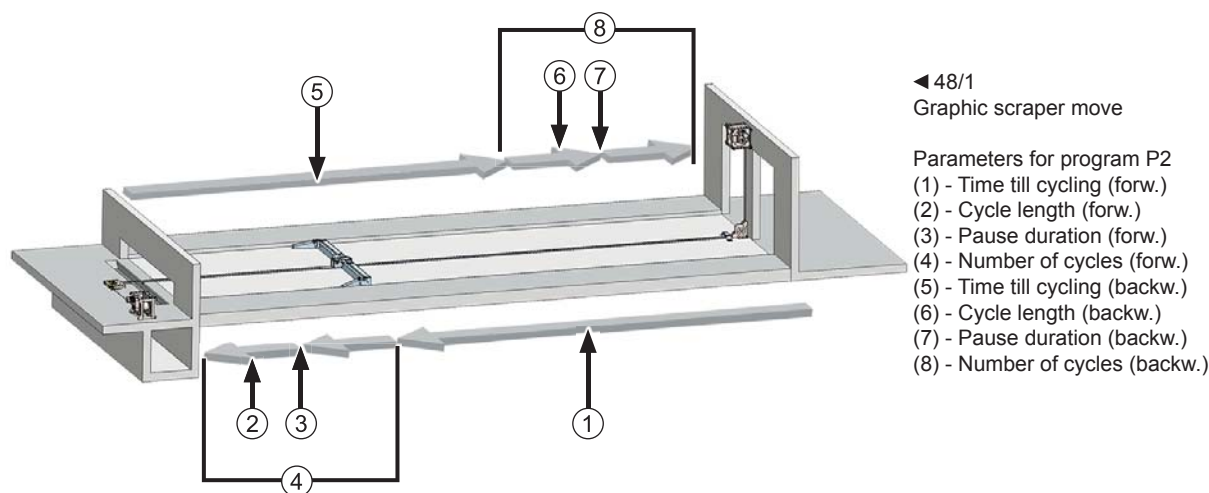

INFO

At the last pause (last cycle before the stop) the distance between the scraper and the stop should be min. 40 cm. If the distance is smaller, it might happen, that the scraper is moving against the stop directly after the starting and the control switches off with the message „error overload“.

Date:	20-11-2014	Data name:	esc300-2-v12a_EN	ESC300 (swv-1.06)
Author:	Heiko Lange	Pages:	72	© P. Prinzing GmbH - 89173 Lonsee-Urspring (Germany)

Set/change the parameter of program P2:

1. **Chose in the main menu an alley (1...6)**
Use the arrow button up/down for the selection
2. **Press ENTER (↵) to open alley (1...6)**
3. **Chose in the menu alley (1...6) „program 2“**
Use the arrow button up/down for the selection
4. **Press ENTER (↵) to open „program 2“**
5. **Chose in the menu 2 „setting forward (backward)“**
Use the arrow button up/down for the selection
6. **Press ENTER (↵) to open „setting forward (backward)“**
7. **Chose in the menu setting forward (backward) a parameter**
Chose: time till cycling- cycle length - duration pause - number of cycles
Use the arrow button up/down for the selection
8. **Press ENTER (↵) to edit the chosen parameter**
9. **Press the ARROW BUTTONS (↑/↓) to change the value**
10. **Press ENTER (↵) to save the changes**
11. **Chose another parameter and repeat point 7-10**
Edit all necessary parameters. Consider the information on the page before.
12. **Press ESC to end the settings of the parameters and to leave the menu „setting forward“**
13. **Press ESC**
The menu „program 2“ will be displayed
14. **Chose „setting backward“ and do the settings for the parameter for the backward motion, as described in point 5-12**
Consider, that there might be different driving times for forward and backward motion.
15. **Press ESC to leave the menu**
Press ESC till the operation mode will be displayed or navigate to another menu item.



▲ 49/1
Menu program 2 - Chose the driving direction for setting the parameters



▲ 49/2
Menu item „setting forward“ - here you can edit the chosen parameters

Date:	20-11-2014	Data name:	esc300-2-v12a_EN	ESC300 (swv-1.06)
Author:	Heiko Lange	Pages:	72	© P. Prinzing GmbH - 89173 Lonsee-Urspring (Germany)

8.2. Display system information

By the display of the remote, you can ask for the following system information:

- current limit = maximum adjustable breaking current corresponding the effective power of the motor
- temperature = display of the current temperature on the feeler
- SW-version = software version
- Par.-version = parameter version
- Operating hours = displays after opening the menu item with **ENTER** (↵) the operating hours of alley 1...6
- Ger.-Nr. = device number of the control

Display the system information

1. **Open the main menu (ESC)**
2. **Chose in the main menu „main settings“**
Use the arrow button up/down for the selection
3. **Press **ENTER** (↵) to open the „main settings“**
4. **Chose in the menu main settings „system information“**
Use the arrow button up/down for the selection
5. **Press **ENTER** (↵) to open „system information“**
The system information will be displayed. Editing is not possible.
6. **Press **ESC** to leave the menu**
Press ESC till the operation mode will be displayed or navigate to another menu item.

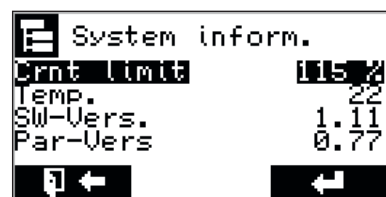

▲ 50/1
Menu system information - Display of important information of the control

8.3. Do a system diagnosis

In the menu „service“ of the control you have got the possibility, testing single components on their function.



ATTENTION

At some functional test, the scraper is moving and the motors are turning. Assure, before doing the functional tests, that there will be no danger for persons or animals.

Service-menu to open the system diagnosis

1. **Open the main menu (ESC)**
2. **Chose in the main menu „main settings“**
Use the arrow button up/down for the selection
3. **Press **ENTER** (↵) to open the „main settings“**
4. **Chose in the menu settings „service“**
Use the arrow button up/down for the selection
5. **Press **ENTER** (↵) to open „service“**
The service items will be displayed. The description of the diagnosis and the single points you can find in the next passage
6. **Press **ESC** to leave the menu**
Press ESC till the operation mode will be displayed or navigate to another menu item.

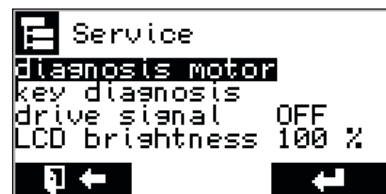

▲ 50/2
Menu service - parameters for the system diagnosis

Date:	20-11-2014	Data name:	esc300-2-v12a_EN	ESC300 (swv-1.06)
Author:	Heiko Lange	Pages:	72	© P. Prinzing GmbH - 89173 Lonsee-Urspring (Germany)

During the system diagnosis you can do the following:

Diagnosis motor

ATTENTION: During this diagnosis, the motors/scrapers are moving!

In the menu item diagnosis motor, the charging rate of the single phases on the motor will be displayed. Therefore do as follows:

1. Open the menu item „diagnosis motor“ with **ENTER** (↵)
2. Chose by the **ARROW BUTTONS** (◀ / ▶) an alley (1...6)
3. Press the button **FORWARD** (▶) an keep the button pressed
The current of motor 1 of the chosen alley will be displayed
4. Press the button **BACKWARD** (◀) and keep the button pressed
The current of motor 2 of the chosen alley will be displayed

Diagnosis button

Here you can test the function of the buttons on the remote.

1. Open the menu item „diagnosis button“ with **ENTER** (↵)
2. Push any button (start - stop - forward - backward)
3. On the display the functionality will be displayed
OFF = not pressed - ON = pressed

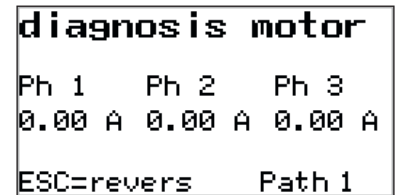

▲ 51/1
Menu „diagnosis motor“ - display of the motor current of phase Ph1 - Ph2 - Ph3

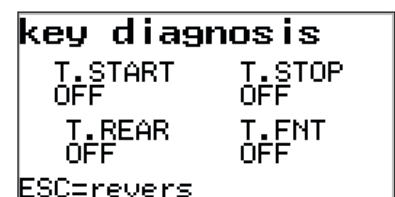

▲ 51/2
Menu „diagnosis button“ - functional test of the push buttons

8.4. The signal output „cross transport“ and „error“

On the control board there is an access „cross transport“ and the access „error“. These both access ports are potential-free changeover contacts (S - X - O) with the following functions and wiring facilities:

Access CROSS TRANSPORT:

- Standard: Signal output for the activation of a cross transport (additional control, relay, or similar)
Option: Signal output for the function „drive“ (e.g. horn, flashing light)

Access ERROR:

- Standard: Signal output for error messages (e.g. horn, flashing light)
Option: Signal output for the function „drive“ (e.g. horn, flashing light)

The respective option for the signal output is only usable, when the standard access is **not** used!

In the **service menu** >>> menu item **signal drive** it is possible to switch the *signal drive* on one of the both changeover contacts. Then the contact will be each time activated for the duration of the „driving time“. That means, when the scraper is moving during the animal driving, there will be a signal by the horn, a flashing light is glowing, or similar.

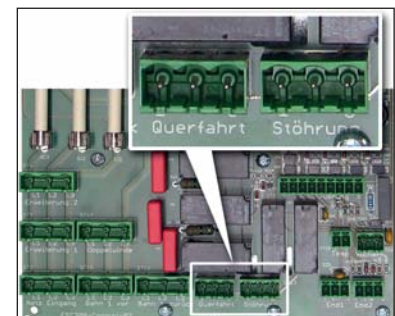

▲ 51/3
Terminal clamp cross transport and error

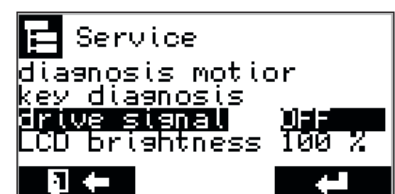

▲ 51/4
Menu „service“ - selection for the „signal drive“

Date:	20-11-2014	Data name:	esc300-2-v12a_EN	ESC300 (swv-1.06)
Author:	Heiko Lange	Pages:	72	© P. Prinzing GmbH - 89173 Lonsee-Urspring (Germany)

* Option / depends on design

8.5. The tension control

The tension control...

- is monitoring the mains voltage of your system
- is adapting the breaking current of the motors automatically to the voltage fluctuations in the net

When there are voltage errors in the single phases, or is voltage limits will exceed or fall below, the error message „voltage error“ will be displayed.

The sensibility of the tension control can be set in the menu item „service“. Factory provided is 15. Meanings of the values:

- 00 = voltage control off
- 01 = sensibility maximum (very sensitive)
- 99 = sensibility minimum (less sensible)

Switch ON/OFF the voltage control or change the sensibility:

- 1. Open the menu item „service“**
Main menu >>> main settings >>> service
- 2. Chose „voltage control“**
Use the arrow buttons up/down for the selection
- 3. Press ENTER (↵) to edit the selection**
- 4. Press the ARROW BUTTONS (↑/↓) to change the value**
Settings see above (e.g. „00“ = tension control off)
- 5. Press ENTER (↵) to save the settings**



▲ 52/1
Menu „service“ - settings voltage control

8.6. Die SD-card (data saver)

The SD-card is in a card support on the control board, up on the left side, next to the power supply and has got the following functions:

- automatic and manual saving (export) of all parameters
- logging of the scraper moves and messages (till the SD-card is full)
- software-update for the system software (board „control“)
- import of saved parameters, e.g. after hardware exchange or data loss

Memory card-type: only SD-cards, SDHC-cards will be **not** supported!
 Memory space: recommended 2 GB (4 GB and more will **not** be supported)
 Type: FAT (standard) or FAT32. NTFS will **not** be supported!

You can find the data on the SD-card as follows:

- on the control by the menu service >>> menu item SD-card
- you are able to open the .csv-files on the PC standard-tabulation program (e.g. MS Excel)



▲ 52/2
Menu service >>> SD-card

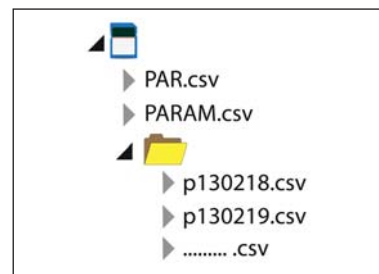

▲ 52/3
File structure on the SD-card



ATTENTION
 Change the SD-card only when the control is switched off (main switch OFF)

Date:	20-11-2014	Data name:	esc300-2-v12a_EN	ESC300 (swv-1.06)
Author:	Heiko Lange	Pages:	72	© P. Prinzing GmbH - 89173 Lonsee-Urspring (Germany)

8.6.1 Insert/extract the SD-card

1. Switch off the main switch of the control, open ESC300
2. Insert the SD-card into the card slot with the labelling to the left
3. Push the SD-card slightly down, till it snaps into place

To extract the SD-card press it slightly down >>> the card unlocks. Now you can extract.



▲ 53/2
SD slot with SD-card

8.6.2 Save parameters (export)

By the backup, it is possible, to import the pervious parameters in case of data loss when changing the hardware.

The backup of the parameters on the SD-card happens as follows...

- Automatically, 1x daily at 03:20 hr (file name: *PAR.csv*).
Thereby the data will be overwritten daily!
- Manual in the menu **main settings** >>> **service** >>> **SD-card**.
The data will be overwritten after each manual backup.
(file name: *PARAM.csv*).

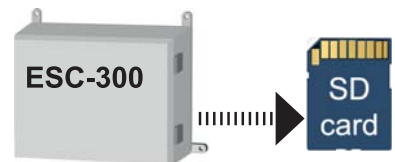

ATTENTION!

During the backup, always the last saved data will be overwritten! The parameter-backup file is in the root-directory of the SD-card (fig: 53/2).



▲ 53/2
Menu item „save data“

Save parameters manual

1. Open the menu item „SD-card“
Main menu >>> main settings >>> service >>> SD-card
2. Chose „save data“
Use the arrow buttons up/down for the selection
3. Press **ENTER** (↵) to confirm the selection
4. A security query will be on the display
5. Confirm the security query by **ENTER** (↵)
The file will be saved as „PARAM.csv“ on the SD-card
6. When the backup is finished, there will be displayed:
„Data backup successful“
On a PC you can check, if the file PARAM.CSV was saved with the current date/ time in the main menu of the SD-card.
ATTENTION! -Wait approx. 30 sec, before you extract the SD-card or switch off the control.
7. Press **ESC** to leave the menu
Press ESC till you are in the operation mode or navigate to another menu item.

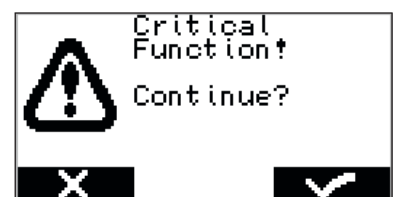

▲ 53/3
Security query

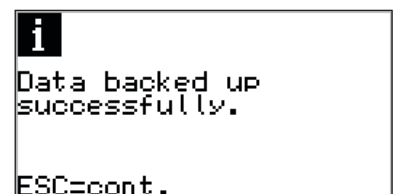

▲ 53/4
Confirmation data backup

Date:	20-11-2014	Data name:	esc300-2-v12a_EN	ESC300 (swv-1.06)
Author:	Heiko Lange	Pages:	72	© P. Prinzing GmbH - 89173 Lonsee-Urspring (Germany)

* Option / depends on design

8.6.3 Load parameters (import)

After changing the hardware, reset of data loss, it is possible to import all saved parameters on you SD-card on the control. By the data import it is not necessary to program the control again.

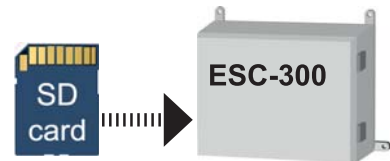

INFO

Parameters for the data import are available...

- when the data were saved manual by the user
- when the control have been 24 hours in operating state (automatic backup)

Variance 1 - menu item **daily backup**

The parameters of the last automatic backup will be memorized. The last backup was max. 24 h ago.

Variance 2 - menu item **import data**

The parameters of the last manual backup will be memorized.

Load parameters (import):

- Open the main menu „SD-card“**
Main menu >>> main settings >>> service >>> SD-card
- Chose „daily backup“ or „import data“**
Use the arrow buttons up/down for the selection
- Press ENTER (↵) to confirm the selection**
- A security query will be on the display**
- Press ENTER (↵) to confirm the selection**
The chosen data will be imported.
- After a successful data import you will see: „Data import successful“**
If there are no manual saved data available, or if the data file is damaged, you will see on the display „Data could not be imported“ .



▲ 54/4
Menu „SD-card“

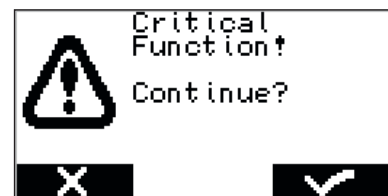

▲ 54/5
Security query



ATTENTION

When importing the parameters from the SD-card, the current saved parameters will be overwritten!



INFO

If there are new parameters because of a software update, there will be the standard value (factory provided) when importing data.

Date:	20-11-2014	Data name:	esc300-2-v12a_EN	ESC300 (swv-1.06)
Author:	Heiko Lange	Pages:	72	© P. Prinzing GmbH - 89173 Lonsee-Urspring (Germany)

8.6.4 Logging on the SD-card

By the logging, the program start, program sequence, tension, voltages and error messages of the single alleys will be recorded. There will be written daily a new log file into the folder „journal“ of the SD-card. The log file will be created as a .csv-file and can be opened with e.g. MS EXCEL. The file name consists of...

Variance, Year (YY), Month (MM) Day (DD). e.g. p130212 (12.02.2013)

There will be written log files into the folder „journal“ till the SD-card is full. When the SD-card is full there will be no monitoring anymore.

On an average operation of the system the capacity of the SD-card will last for (2 GB) approx. 5-7 years.

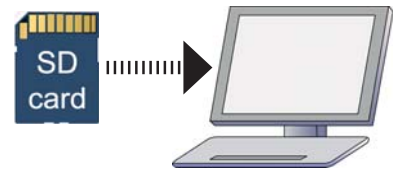

TIP
Delete regularly (6-12 months) the oldest, not dedeed log files. So you can keep the logging clearly arranged.

ATTENTION
Switch off the control before extracting the SD-card! (Main switch OFF)

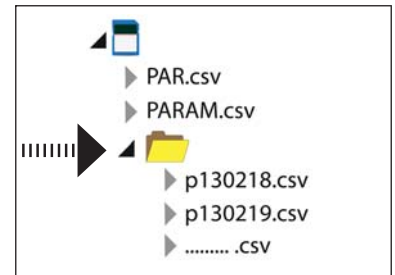

▲ 55/1
Folder with log files on the SD-card

8.6.5 Software-Update with a SD-card

ATTENTION
Save before each system update your settings and parameters on the SD-card! (see page 55)
Switch off the control before changing the SD-card (Main switch OFF)

By the help of a prepared SD-card a software update on the ESC300 can be done. For the software update you need:

- an empty SD-card (max. 2 GB-card. No SDHC/SDXC cards!)
- a current update file (CONTROL.bin)

The function „System-Update“ you can find in the menu **Main settings >>> Service >>> SD-card.**

The current software and a detailed description how to do the update you can find...

- in the software update (per download, E-Mail or by post)
- by an inquiry: service-entmistung@prinzing.eu



▲ 55/2
Menu item „System-Update“



▲ 55/3
Update-file on the SD-card

Date:	20-11-2014	Data name:	esc300-2-v12a_EN	ESC300 (swv-1.06)
Author:	Heiko Lange	Pages:	72	© P. Prinzing GmbH - 89173 Lonsee-Urspring (Germany)

* Option / depends on design

8.7. Failure and error deletion

Failures and errors on the dung removal system you can see when...

- there is no program or an incomplete program
- there is an error message on the display of the control

When there is an error first check the following points:

- Connection of the feed line on the power distribution and the control (firm sat of the contacts)
- Connected load on the power input of the control (3x 380-400 V)
- Fuses in the system on connecting passage. Dismount the fuses therefor!!!
- Professional connection of all components (motors, buttons, EXP300)
- Check cables and lines on mechanical or thermal damages (drilled, squashed, or similar)
- Outside electrical interferences (voltage drop by user e.g. pump, electric smog)
- Function of mechanic parts (scraper, winches, guide pulleys, motor-gear)
- Check walkway and guide bars on obstacles, e.g. edges, screws, nails

8.7.1 Error messages on the display - cause and deletion

Error messages on the display:

- the display light changes to red
- on the alley display, the symbol " ! „ is over the affected alley

Change by the arrow buttons (◀ / ▶) on the alley marked with the " ! „. Here the error message will be displayed as code (e.g. E01) and as text.

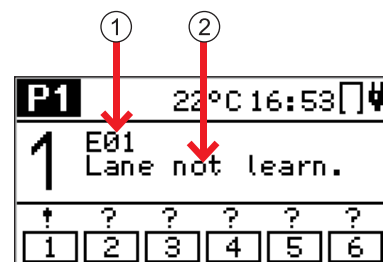

▲ 56/1
Error message with code (1) and description (2)

How to receipt an error message:

- 1. Change with the arrow buttons (◀ / ▶) on the alley marked with the " ! „**
The error code will be displayed. Note down the message if necessary for a later contact with the service.
- 2. Delete the cause for the error if it is possible (e.g. obstacle)**
- 3. Receipt the error message by ENTER (◀)**
If there is still the error message, please contact our service.



▲ 56/2
Receipt error message:

1. chose alley
2. read message and note down if necessary
3. press **ENTER**



INFO

Error messages will be only displayed in the window of the affected alley (1..6) and can be receipt (reset) only in this window!

Before you receipt the error message:

- note down the error code
- delete the cause of the error message

Date:	20-11-2014	Data name:	esc300-2-v12a_EN	ESC300 (swv-1.06)
Author:	Heiko Lange	Pages:	72	© P. Prinzing GmbH - 89173 Lonsee-Urspring (Germany)

8.7.2 Error codes

INFO - Receipt the error messages by pressing **ENTER** (↵)

Code	Error	Cause	Deletion
E01	Alley not learned	The program learning or teaching was not executed for this program.	Do program "learning" or "teaching" for this program
E02	Error Emergency stop	<ul style="list-style-type: none"> - emergency stop connected not/wrong - emergency stop pressed - emergency stop line faulty - emergency stop relay broken 	<ul style="list-style-type: none"> - check emergency stop buttons - unlock emergency stop button - check emergency stop line - replace board "Control"
E03	Error obstacle	An obstacle was detected during the automatic operation	Receipt the error message >>> move scraper manual in home position
E04	Manual operation	The scraper was moved by the push buttons on the alley board	Receipt error message >>> the alley will be controlled again over the „Control“-board
E05	Error phase L1	No current flow on the phase <ul style="list-style-type: none"> - phase to the motor interrupted - connection on the motor faulty - connection of the bard faulty - fuse for the phase motor broken - board (control, relay) broken 	<ul style="list-style-type: none"> - check line voltage on the board - check connection on the motor or the board - check line on the motor on connecting passage - check fuse on board - replace board (control, relay)
E06	Error phase L2		
E07	Error phase L3		
E08	Error overload	The nominal current of the motor was exceeded <ul style="list-style-type: none"> - the scraper moves directly after starting against an obstacle, e.g. stop - wrong motor nominal current (motor type) was adjusted on the control - scraper is clamping, e.g. frozen 	<ul style="list-style-type: none"> - check/adapt settings motor type - relieve the scraper from the obstacle/stop (manual operation) - keep the minimum distance to the stop (see page 11) - make scraper passable
E09	Error standby current	There is no current when motor is OFF <ul style="list-style-type: none"> - contacts of the relay is clotted - input signal relay is broken 	Plug out both motor lines of the affected alley >>> contact Prinzing-service >>> replace board
E10	Error rope breakage forw.	<ul style="list-style-type: none"> - function „learning“ was not done - the current driving time is higher than the learned time (incl. tolerance time) - tension rope is broken 	<ul style="list-style-type: none"> - replace broken tension rope - if tension rope is not broken, then do the program "learning" for this alley
E11	Error rope breakage backw.		
E12	Error temp. sensor	<ul style="list-style-type: none"> - temperature sensor not connected - temperature sensor broken 	<ul style="list-style-type: none"> - check connection/line of temp. sensor - replace temp. sensor
E13	Voltage error	Voltage was/is below 300 V	<ul style="list-style-type: none"> - check line voltage - rise adjustment of tension control - switch off tension control („0“)
E14	Phases- error	<ul style="list-style-type: none"> - min. 1 phase is missing on the mains supply - min. 1 phase was connected twice - N-conductor was connected on phase 	<ul style="list-style-type: none"> - check mains supply - do not connect an N-conductor on the control!
E15	Wrong date	Date and time were not set yet or have been reset on "0" because the control was switched off too long	<ul style="list-style-type: none"> - receipt error message - set date and time (see page 24)

Date:	20-11-2014	Data name:	esc300-2-v12a_EN	ESC300 (swv-1.06)
Author:	Heiko Lange	Pages:	72	© P. Prinzing GmbH - 89173 Lonsee-Urspring (Germany)

* Option / depends on design

Service: +49 (0) 7336 - 961018

8.7.3 Info messages (display glows yellow)

Message	Description
Drive active - learning not possible	Function drive was activated and the program "learning" tries to start
Learning active - drive not possible	During the learning of an alley, the function "drive" tries to start
No communication with the basis	Radio contact remote <> control disconnected: <ul style="list-style-type: none"> - Main switch control is OFF - Antenna (radio module) not connected or cable to the radio module disconnected - Range remote <> control exceeded - Damage on the radio module or the remote >>> contact PRINZING-after sales service
Battery empty / almost empty	Battery empty, load <i>Remote</i>
Frost active - learning not possible	Frost program is switched on. To learn you have to switch off the frost program.

8.7.4 Errors during the operation (display glows red) - cause and deletion

Error	Cause	Deletion
Breaking current is permanent over 95%	wrong motor type adjusted	Check motor type (name plate) and adapt settings
	mechanical problem on the system (e.g. guide pulley)	check components on stiffness and make it practicable
	gear oil in the motor	<ul style="list-style-type: none"> - check motor on leaking oil - replace gear motor
	motor underdesigned	mount a stronger motor
In program P1 the scraper move will be switched over/off premature	obstacle in the walkway	check walkway on obstacles (e.g. edges, gaps, guide bars)
	breaking current adjusted too low	<ul style="list-style-type: none"> - do learning program - adjust breaking current higher
	mains failure or button STOP was pressed during the scraper move	
Scraper move does not start automatically	automatic not switched on	switch on the automatic
	no starting times adjusted in the timer	adjust starting times in the schedule
It is not possible to chose an alley or to work with it	the alley is switched off	switch on alley
	push button is broken	functional test „diagnosis button“
	radio contact was interrupted	<ul style="list-style-type: none"> - check radio contact (symbol), - lower the distance to the radio receiver

Date:	20-11-2014	Data name:	esc300-2-v12a_EN	ESC300 (swv-1.06)
Author:	Heiko Lange	Pages:	72	© P. Prinzing GmbH - 89173 Lonsee-Urspring (Germany)

Error	Cause	Deletion
Scraper/control is not or bad reacting on keystroke on the remote	radio contact is bad or interrupted	<ul style="list-style-type: none"> - lower distance between remote <> radio module - check assembling of the radio module (see page 11) - install an additional radio module
Set or changed parameters can not be saved	settings were not saved by the ENTER button	after setting/changing values always save with ENTER
Date and time are reset	control was switched off for a longer time (> 48 h)	readjust date and time
The <i>status indication alley</i> displays of all alleys an ?	mains voltage was interrupted, current dataset is lost	after a complete scraper drive the positions will be displayed again
Parameter-dataset not load	When starting, it was not possible to load one of the two parameter-dataset out of the EEPROM.	switch off/on the system

8.7.5 Further errors

Error	Cause	Deletion
Control is not booting completely after starting. Display is glowing but not message on the display.	Defective SD-memory card	<ul style="list-style-type: none"> - extract the SD-card, reformat (FAT FAT32) or use new SD-card - use new SD-card (max. 2GB)
Not possible to save data on the SD-card	wrong or faulty SD-card, write protection of the SD-card active	<ul style="list-style-type: none"> - extract SD-card and reformat (FAT/ FAT32) - use new SD-card (max. 2 GB) - deactivate write protection

Date:	20-11-2014	Data name:	esc300-2-v12a_EN	ESC300 (swv-1.06)
Author:	Heiko Lange	Pages:	72	© P. Prinzing GmbH - 89173 Lonsee-Urspring (Germany)

* Option / depends on design

Service: +49 (0) 7336 - 961018

8.8. Batteries on the remote - care and replacement

The power supply of the remote happens by 4 rechargeable batteries of the type: **AA HR6 NiMH** (min. 2200 mA/h)

When it is completely load, the remote has got a capacity of approx. 24 h. The capacity of the batteries depends on the charging condition, ambient temperature, use and the age. You should load the remote regularly in the charging station, minimum once a day, completely (min. 6 hours) . The current capacity of the batteries will be shown on the display (fig: 60/1).

If the capacity is sinking very fast, even the remote was fully load, you have to change the batteries.

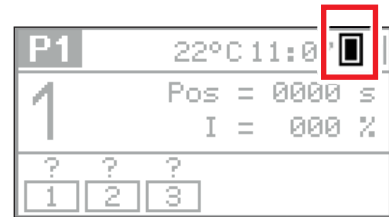

▲ 60/1

Capacity display - of the batteries in the remote display



ATTENTION

Use only rechargeable batteries which are stated in the technical data.

If using unsuitable batteries, there might be the danger of fire or explosion!

Change the batteries on the remote:

1. **Open the battery case on the backside of the control**
Loosen therefor the fastening screws on the case am (60/2)
2. **Extract all batteries out of the battery case**
3. **Insert 4 new batteries into the battery case**
ATTENTION! Consider the polarity!
4. **Close the battery case on the backside of the remote**
Retighten the fastening screws.
5. **Charge the new batteries completely on the charging station**



▲ 60/2

Battery case - with fastening screws



INFO

Batteries do not belong in household waste!

Date:	20-11-2014	Data name:	esc300-2-v12a_EN	ESC300 (swv-1.06)
Author:	Heiko Lange	Pages:	72	© P. Prinzing GmbH - 89173 Lonsee-Urspring (Germany)

8.9. Factory provided (Reset)

By the menu item **factory provided** in the menu **Service** you can reset all settings on you control.
Use this option...

- when you want to reprogram your control and you want to delete all old data
- when there are often abnormalities/functional disturbances during the program sequence
- when there is no way to change the faults of the controls software



INFO

Consider, that after a reset of the control, all personal settings will get lost. Only the data on the SD-card will stay.



ATTENTION

After each manual backup, the last data will be overwritten with the current settings/parameters.

Reset the control:

1. Open the main menu (ESC)
2. Chose in the main menu „main settings“
Use the arrow buttons up/down for the selection
3. Press **ENTER** (↵) to open the „main settings“
4. Chose in the menu main settings „Service“
Use the arrow buttons up/down for the selection
5. Press **ENTER** (↵) to open „Service“
6. Chose in the menu service „reset“
Use the arrow buttons up/down for the selection
7. Press **ENTER** (↵) to reset the control
The security query „perform ?“ is on the display
8. Confirm the security query with **ENTER** (↵)
All parameters will be reset. On the display will be the message „Reset Parameter - please wait...“.
9. After successful reset you will see „Reset OK“
10. Press **ESC** to leave the menu
Press ESC till you are in the operation mode or navigate to another menu item.

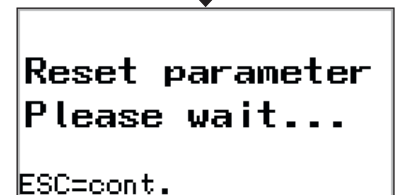

Date:	20-11-2014	Data name:	esc300-2-v12a_EN	ESC300 (swv-1.06)
Author:	Heiko Lange	Pages:	72	© P. Prinzing GmbH - 89173 Lonsee-Urspring (Germany)

* Option / depends on design

9. Factory provided parameters

Parameter		Option/area	Now
• Main settings			
Language	GER	ENG,FRE, RUS	
Date	current	set	
Time	current	set	
Alley selection	1 (On)	2...6 (On/Off)	
• Frost mode (sub menu)			
Switch on temp.	0°C	-25°C...50°C	
Interval time ❄	60 min	1...90 min	
Interval time ❄❄❄	10 min	1...90 min	
Delay (frost)	10 min	5...30 min	
• Obstacle (sub menu)			
Time reverse	10 sec	0...60 sec	
Number trials	3	0...99	
• Service (sub menu)			
Signal drive	Off	On, error, cross transport	
Lightness LCD	100 %	0...100 %	
Tension control	15	0...99	

Parameter		Option/area	Now
• Menu alley (1...6)			
Automatic	Off	On	
• Setup (sub menu)			
Motor type forward	0,55 kW	0,75 - 0,9 - 1,1 - 1,5	
Motor type backward	0,55 kW	0,75 - 0,9 - 1,1 - 1,5	
Switch off forward	80 %	1...115	
Switch off backward	80 %	1...115	
• Schedule (sub menu)			
Time	00:00	00:01...24:00 (24x)	
Program	P1	P2 - P3 - P4	
• Drive (sub menu)			
Drive	Off	On	
Driving time	15	0...6000	
Slatted floor	Off	On	
• Frost mode (sub menu)			
Frost mode	Off	On	
Frost program-type	P1	P2 - P3 - P4	
• Program 2 (sub menu)			
Time till cycling	0	learning or manual	
Cycle length	15 sec	0...6000	
Pause duration	5	0...6000	
Number cycles	3	0...99	
Parking position	0	0...6000	
• Program 3 (sub menu)			
Adaption forward	0,0	-9,9...+9,9	
Adaption backward	0,0	-9,9...+9,9	
• Cross transport			
Cross transport forw.	Off	On	
Cross transport back.	Off	On	
Duration cross transport	1	1...9999	

Date:	20-11-2014	Data name:	esc300-2-v12a_EN	ESC300 (swv-1.06)
Author:	Heiko Lange	Pages:	72	© P. Prinzing GmbH - 89173 Lonsee-Urspring (Germany)

10. Disassembly and Disposal

During the disassembly of the control, always adhere to the applicable legal and operational provisions. Dispose of the material in an environmentally compatible way and in accordance with the currently valid statutory and company-internal rules and regulations.



ATTENTION

Danger of electric shock because of non switched off voltage!

Assure before disassembling the system, that...

- *the system is de-energized*
- *the system is protected against resetting*

Information about the disposal

1. Inside the European Community

If your product is marked with this symbol, exhausted electric/electronic products should not be disposed of along with common household waste. There is a separate collection system in place for these products. Used electrical/electronic devices must be handled separately and in accordance with the legal guidelines regarding the proper handling, disposal and recycling of such products. According to the implementation by member countries, private households within the European Community can dispose of their used electrical/electronic devices free of charge at the respective collection sites.

Applicable guidelines therefor are:

- european guideline of waste products (2008/98/EG)
- the Closed Substance Cycle Waste Management Act (KrW-/AbfG)
- the electric and electronic guideline - ElektroG
- guideline 2012/19/EU of the european parliament dated 4. July 2012 about electric and electronic old appliances

2. In countries outside the EC

If you wish to dispose of this product, please contact your local authorities to obtain information about the proper disposal.

3. USED BATTERIES (Guideline for Germany)

Batteries and battery packs do not belong in the household trash!

In the interest of the environmental protection, as per the current laws regarding battery disposal, you are obliged to return used and depleted batteries and battery packs. You can return the used batteries to all GRS collection sites at your location or everywhere, where batteries are sold. These batteries will be accepted free of charge.

Date:	20-11-2014	Data name:	esc300-2-v12a_EN	ESC300 (swv-1.06)
Author:	Heiko Lange	Pages:	72	© P. Prinzing GmbH - 89173 Lonsee-Urspring (Germany)

* Option / depends on design

11. Technical data

for the electronic control Comfort ESC300

General information

These technical data apply for the type	ESC300
Measurements ESC300 (B x H x T) without screwing	500 x 400 x 220 mm
Measurements EXP300 (B x H x T) without screwing	400 x 300 x 190 mm
Max. tensile load of the connected winch (depending on type)	1000 kg - 2200 kg
Usable winch types	EWB 4 - EWB 5 - EWB 6 - DW 7
Safety class	IP54
Ambient temperature	-20...50 °C
Atmospheric moisture	max 75 %

Electric connecting values

Mains voltage	400 V / 3~ / PE (50-60 Hz)
Control voltage	18 - 24 V DC
Current drain in standby-mode.	approx. 5 W
Switching outputs motor.	max. 3,5 A/Phase
Outlet „error“.	1 A (24 V DC) - 4 A (230 V AC)
Outlet „cross transport“.	1 A (24 V DC) - 4 A (230 V AC)
Cross section terminal clamp net + motors	max. 2,5 mm ²
Cross section terminal clamp control cable	max. 1,5 mm ²
Usable motors	0,55 kW-HM333S/4D71B-4 (ABM)
.	0,55 kW-FDAZ 61-M1P4H-01-A (Himmel)
.	0,75 kW-FGA1353/4D80B-4 (ABM)
.	0,9 kW-GFL 7-3MHDR-080-32 (Lenze)
Measuring range temperature sensor:	-25 - 90°C

Radio control unit "Remote"

Transmission power:	max. 12.86 dBm (19 mW).
Range.	300 m (at line of sight)
Battery-type:	AA HR6 NiMH 2850 (rechargeable)
Battery-running time when completely load (depending on use)	approx. 24h

Battery charging station „Charge“

Measurements (B x H x T) without screwing	234 x 264 x 141 mm
Mains voltage	230 V AC

Date:	20-11-2014	Data name:	esc300-2-v12a_EN	ESC300 (swv-1.06)
Author:	Heiko Lange	Pages:	72	© P. Prinzing GmbH - 89173 Lonsee-Urspring (Germany)

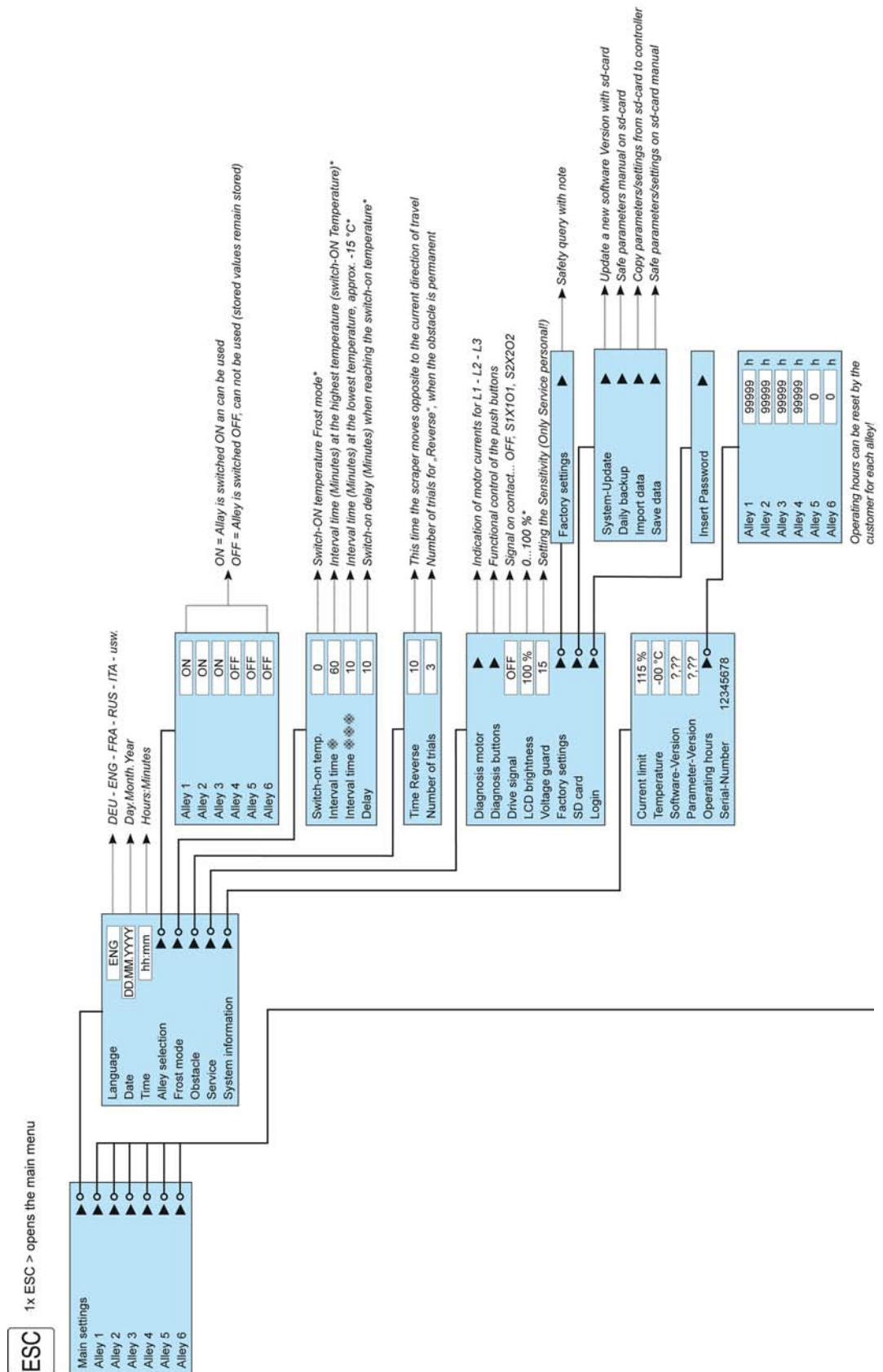

continued on page 66

Date:	20-11-2014	Data name:	esc300-2-v12a_EN	ESC300 (sw-1.06)
Author:	Heiko Lange	Pages:	72	© P. Prinzing GmbH - 89173 Lonsee-Urspring (Germany)

* Option / depends on design

Service: +49 (0) 7336 - 961018

continued from page 65

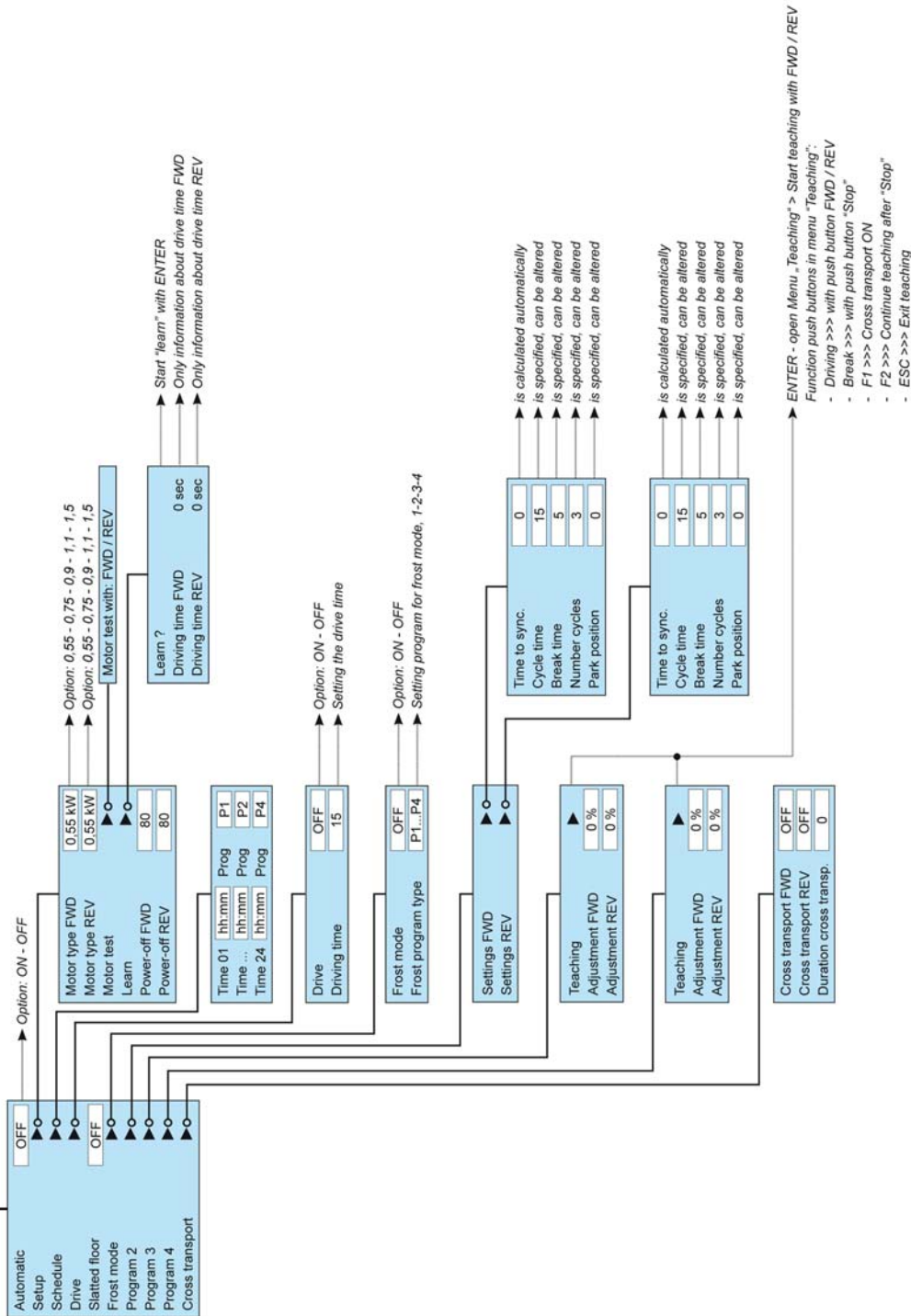

Date:	20-11-2014	Data name:	esc300-2-v12a_EN	ESC300 (sw-1.06)
Author:	Heiko Lange	Pages:	72	© P. Prinzing GmbH - 89173 Lonsee-Urspring (Germany)

CHARGE

ESC300

EXP300

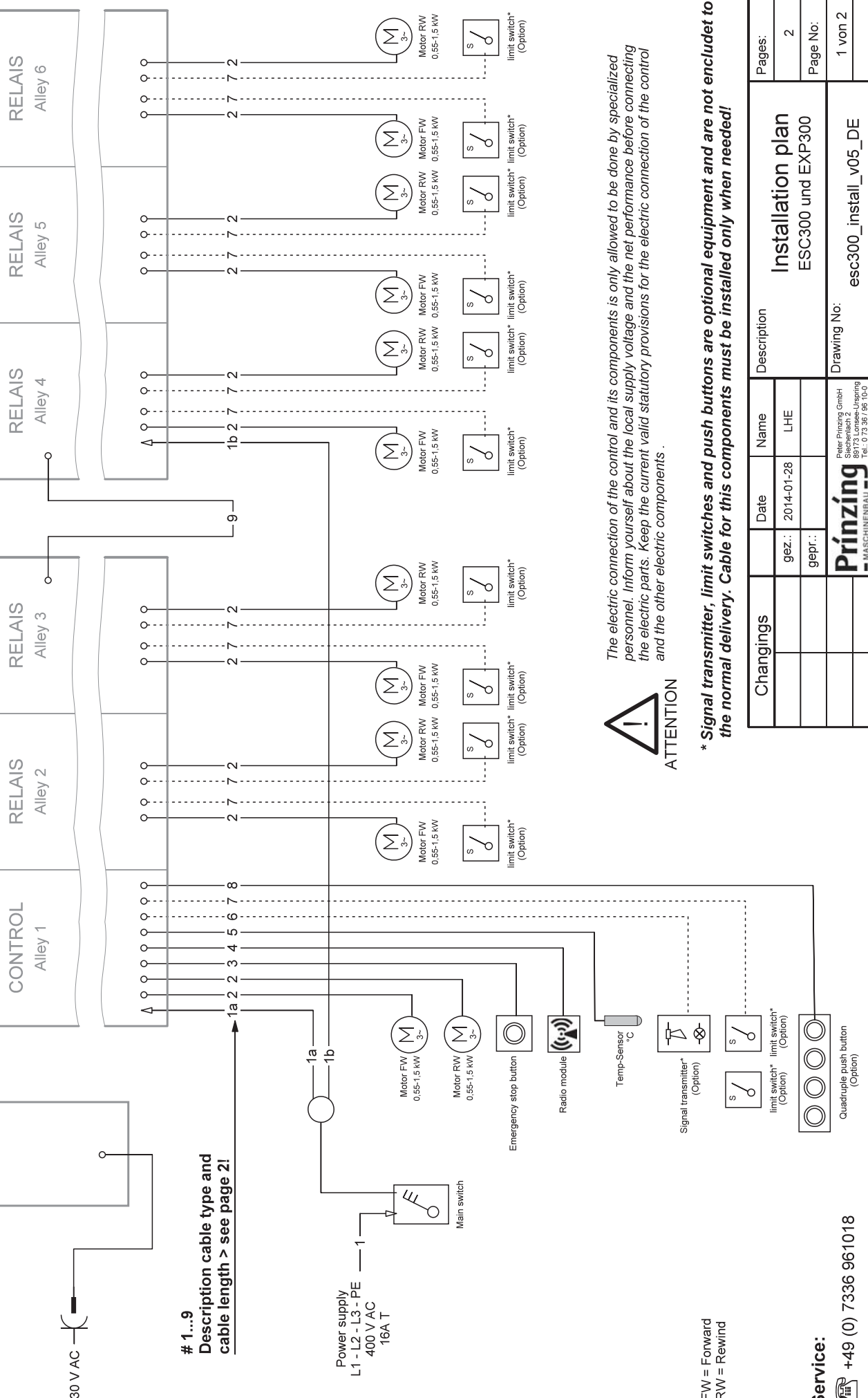

1...9
Description cable type and
cable length > see page 2!

Power supply
L1 - L2 - L3 - PE
400 V AC
16A T

FW = Forward
RW = Rewind

Service:
+49 (0) 7336 961018



ATTENTION
The electric connection of the control and its components is only allowed to be done by specialized personnel. Inform yourself about the local supply voltage and the net performance before connecting the electric parts. Keep the current valid statutory provisions for the electric connection of the control and the other electric components.

* Signal transmitter, limit switches and push buttons are optional equipment and are not included to the normal delivery. Cable for this components must be installed only when needed!

Changings	Date	Name	Description
gez.:	2014-01-28	LHE	
gepr.:			

Pages:		2
Page No.:		1 von 2
Drawing No.:		esc300_instal_v05_DE
Description:		Installation plan ESC300 und EXP300

#	Component	Recommended line type	Min. No. of leads	Voltage	Max. length
1	Feed line ⁽¹⁾ to the main switch	NYM 5 x 1,5 (2,5) mm ²	4	400 V / 3~ / 50 Hz	---
1a	Feed line ⁽¹⁾ to the ESC300 from the main switch / conduit box	NYM 5 x 1,5 (2,5) mm ²	4	400 V / 3~ / 50 Hz	---
1b	Feed line ⁽¹⁾ to the EXP300 from the main switch/ conduit box	NYM 5 x 1,5 (2,5) mm ²	4	400 V / 3~ / 50 Hz	---
2	Motor wire rope winch	NYM 5 x 1,5 mm ²	4	400 V / 3~ / 50 Hz	150 m
3	Emergency stop button ⁽²⁾	NYM 3 x 1,5 mm ²	2	24 V DC	150 m
4	Radio module ⁽⁴⁾	LIYCY 8 x 0,5 mm ² ROHS	8	24 V DC	100 m
5	Temperature sensor	NYM 3 x 1,5 mm ²	2	5 V DC	10 m
6	Transmitter / cross transport - (option)	NYM	2	max. 250 V-AC/4 A - 24 V-DC/1 A	---
7	End switch mechanical (option)	LIYCY 2 x 0,5 mm ² ROHS	2	24 V DC	150 m
	End switch proximity switch (option)	LIYCY 3 x 0,5 mm ² ROHS	3	24 V DC	150 m
8	External operating keys (push buttons) / (option)	LIYCY 12 x 0,5 mm ² ROHS	6	24 V DC	100 m
	Data bus Expansion	LIYCY 5 x 0,5 mm ² ROHS	5	24 V DC	5 m
	Safety shutdown board ⁽³⁾ - (release cable from the control) / (option)	NYM 3 x 1,5 mm ²	2	24 V DC	See emergency stop button

Consider the following information about the list:

- (1) Define the cable cross section corresponding the motor power and the length of the line. If necessary mount a conduit box after the main switch, to separate the feed line of the ESC300 and the EXP300.
- (2) Emergency stop button - we recommend to mount min. one emergency stop button per drive unit (alley)! The stated max. line length is the same as the cable length of the emergency stop line. By a series connection of the emergency stop controls, there will be an effective line length of maximum 300 m.
- (3) The controls release cable of the safety shutdown board to the ESC300 will be integrated into the emergency stop line circuit and must be, according to this, considered for the maximum line length of the emergency stop.
- (4) The used cable has to be screened and twisted. To increase the radio signal, it is possible to connect max. 2 radio modules (concatenated in series or parallel). The max. line length per radio module is 100 m. This equates for 2 concatenated radio modules a length of max. 200 m.

Information about the lines for low voltage up to 24 V DC

It is not allowed to install current circuit with low voltage and mains voltage in the same wiring system. Consider for low voltage lines, that there might be disturbances/maifunctions on the ESC300 by coupling of electromagnetic fields.
Do not lay the low voltage lines together with the electric power line, but separated with a spacer. Keep the length of the lines as short as possible when there is low voltage. The shielding of cables should be placed on one side of the ground (earth):

Notes on optional accessories!

Signal transmitter, end switches and push buttons are optional equipment and are not encludet to the normal delivery.
Cable for this components must be installed only when needed!

Service:  +49 (0) 7336 961018

Changings		Date	Name	Description
	gez.:	2014-01-28	LHE	Installation plan ESC300 und EXP300
	gepr.:			
 <small>Peter Prinzing GmbH Sleichenlaach 2 99793 Lonsee-Uspring Tel.: 0 73 36 96 100</small>				Drawing No: esc300_install_v05_DE
				Pages: 2
				Page No: 2 von 2

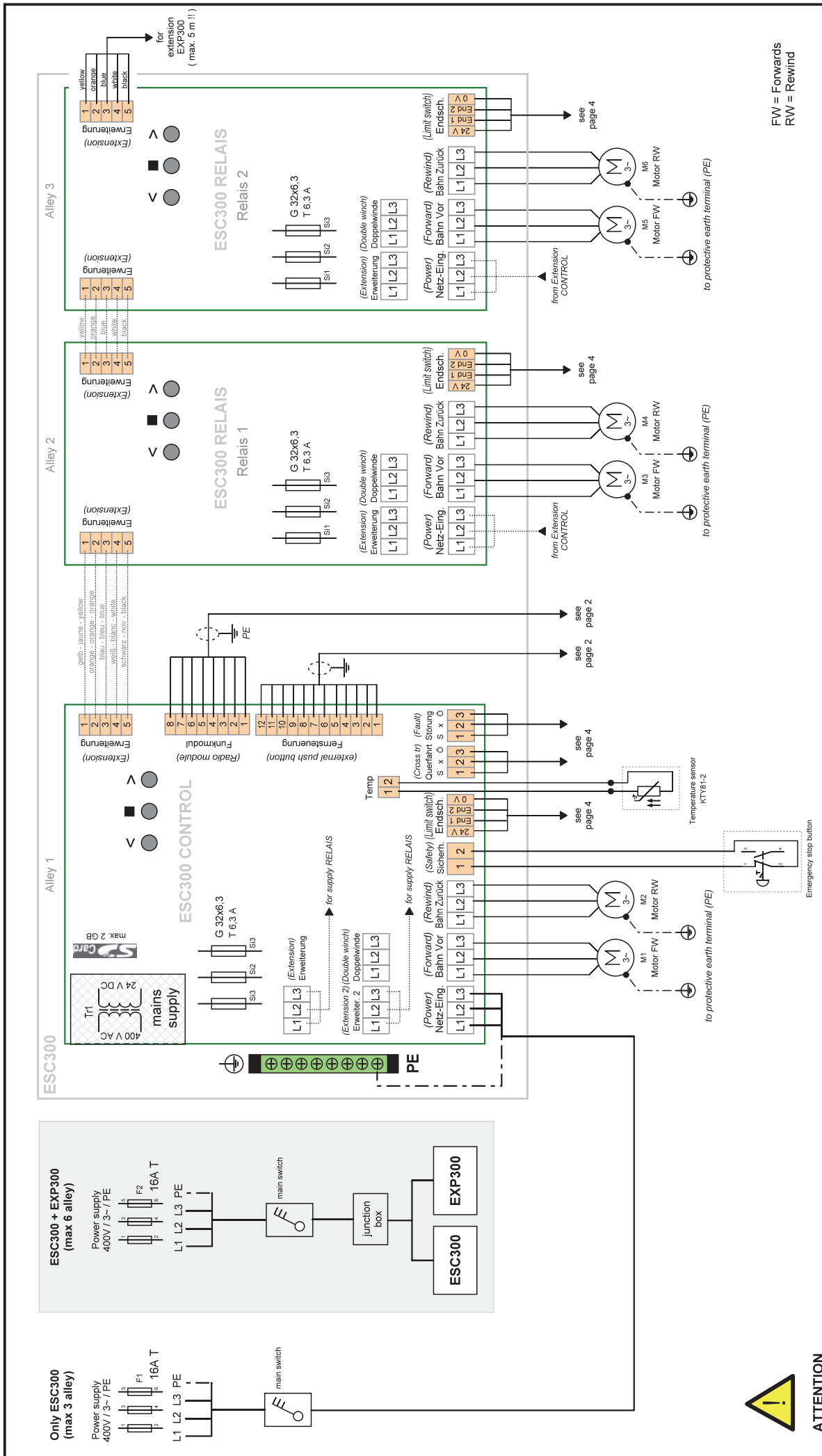

ATTENTION
 Into the feed line of the control you have to integrate a main switch.
 Mount the main switch close to the control.

..... Pre-wired in the control!

Changings	Date	Name	Description
	gez.: 2014-11-20	LHE	Connecting plan ESC300
	gepr.:		

Drawing-No: esc300_ap_v10_EN	
Pages	4
Page-No:	1 von 4

Prinzing
 MASCHINENBAU
 Peter Prinzing GmbH
 Stechenlaach 2
 99173 Lönsee-Ürspring
 Tel. 0 73 36 / 96 10-0

Connecting external pushbuttons

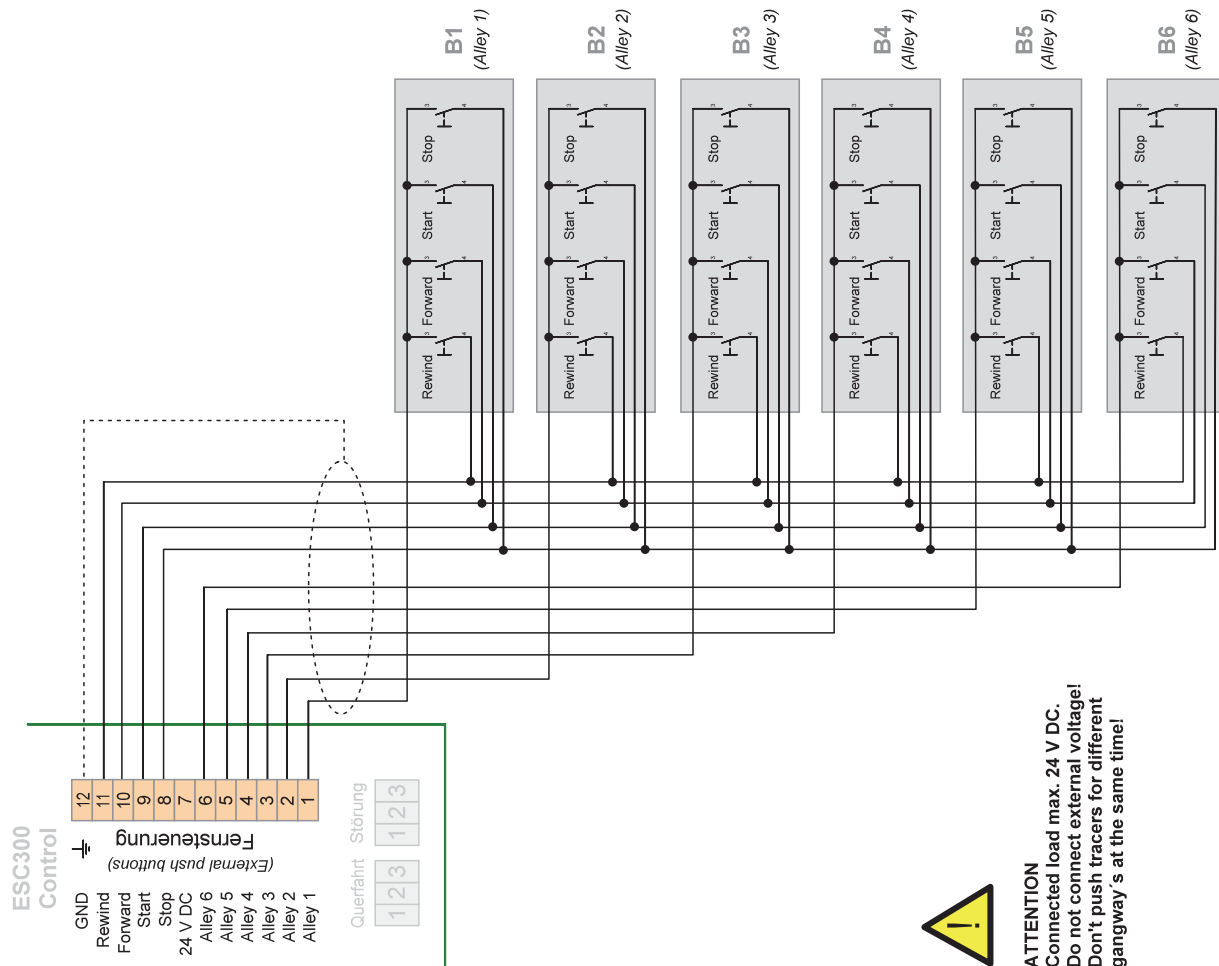

ATTENTION
 Connected load max. 24 V DC.
 Do not connect external voltage!
 Don't push tracers for different
 gangway's at the same time!

ATTENTION - Connect no external voltage!

Connecting radio module

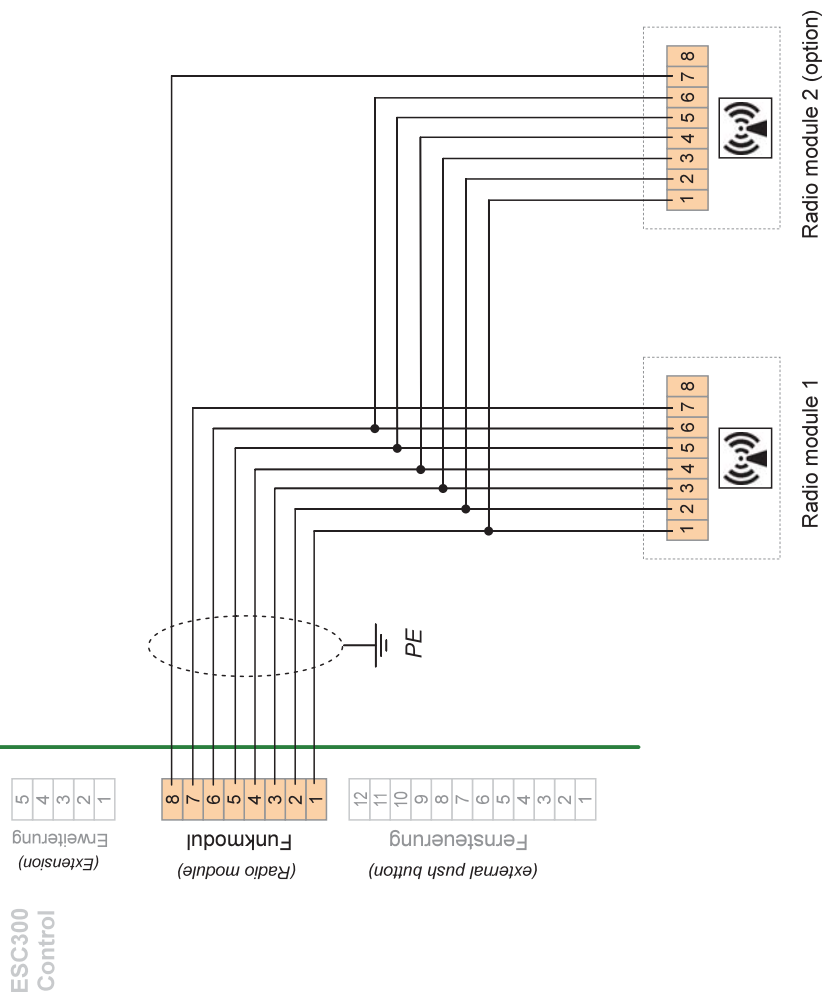

Together twisted wires please connect in pairs !
 1+2 = 1 wire pair (twisted)
 3+4 = 1 wire pair (twisted)
 5+6 = 1 wire pair (twisted)
 7+8 = 1 wire pair (twisted)

Changings	Date	Name	Description	Pages
gez.:	2014-11-20	LHE	Connecting plan ESC300	4
gepr.:				Page-No.:
			Drawing-No.:	2 of 4

Prinzing
 -MASCHINENBAU
 Peter Prinzing GmbH
 Stechenlach 2
 89173 Leneise-Uspring
 Tel.: 0 73 36 / 96 10-0

